

ASSEMBLY INSTRUCTIONS AND WARRANTY  
 MANUAL DE ENSAMBLE Y GARANTIA

**REF.: AM 16423**

**ARMOIRE**

**ARMARIO**

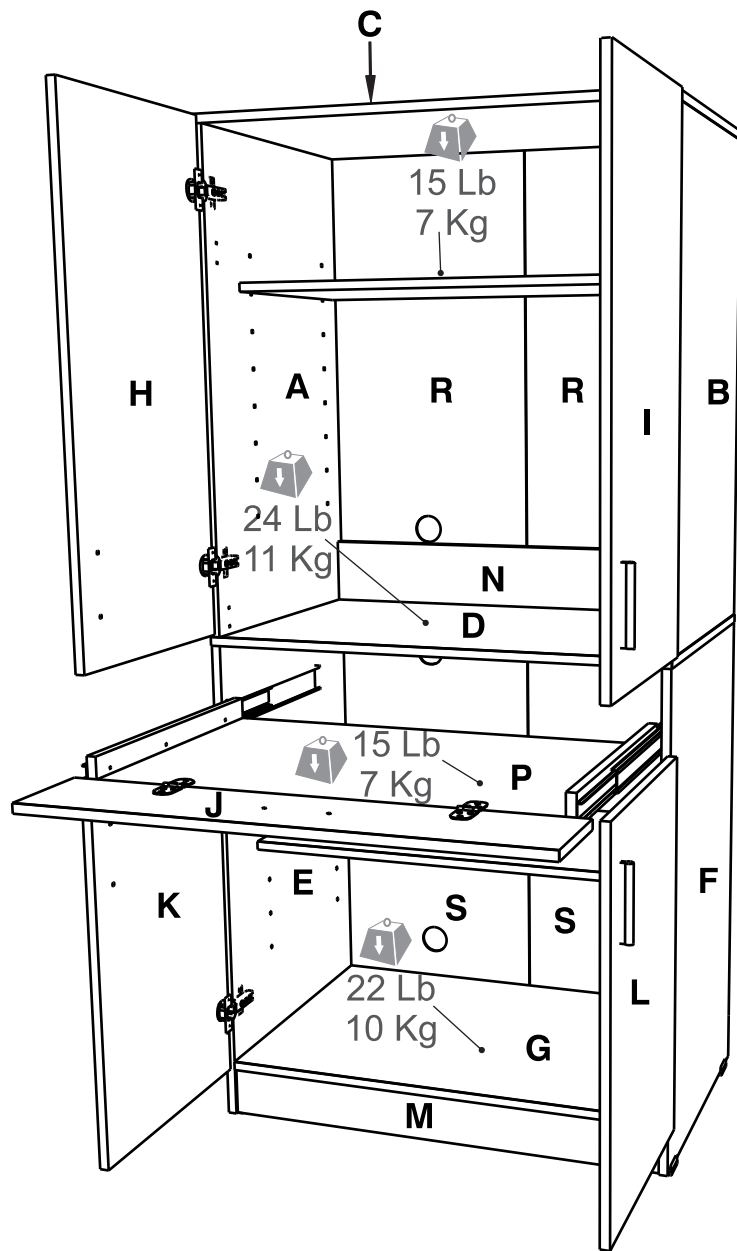

**IMPORTANT!**

When calling or writing us, please provide the OP number, here highlighted, so we can offer the most efficient response.

**¡IMPORTANTE!**

Al llamar o escribirnos, por favor darnos el número de OP, aquí resaltado, con el fin de ofrecerle la respuesta mas eficiente.

**INFORMACION DE PRODUCTO**

**OP: 38547**

**DATE: 30/05/2018**

**FINISH: ARENA / LARICINA II**

**INVAL**

El mueble que uno quiere

Furniture that you want



## DO NOT RETURN TO STORE

Do not contact store for parts or assembly assistance. Individual stores do not stock parts. For fast, efficient and friendly service please contact us at the numbers below Monday thru Friday from 9:00 a.m. to 5:30 p.m. ET If your place of residence is any other country but the United States of America or Canada, please contact your retailer immediately and inform them about your problem. They will provide instructions applicable to your country of where and how to obtain spare parts or help in assembling INVAL products.

## NO DEVUELVA ESTE PRODUCTO A LA TIENDA

Si usted reside en los Estados Unidos de América o Canadá, por favor no regrese o llame telefónicamente a su vendedor para solicitar piezas de repuesto o para ayuda durante el ensamblaje. Su vendedor no tiene inventario de repuestos. Para una rápida y eficiente ayuda por favor comuníquese con nuestros números abajo de lunes a viernes desde las 9:00 a.m. hasta las 5:30 p.m. hora del este. Si usted reside en cualquier otro país que no sea Los Estados Unidos de América o Canadá por favor comuníquese a su detallista inmediatamente de su problema. Él le dirá adonde dirigirse en cada país para obtener piezas de repuesto o ayuda para ensamblar su mueble de INVAL.

## NE PAS RETOURNER CE PRODUIT AU MAGASIN

Ne pas contacter le magasin afin d'obtenir des pièces ou une assistance technique. Les magasins ne possèdent pas de pièces en stock. Pour en Service après-vente rapide, efficace et amical, veuillez contacter nos numéros ci-dessous, du lundi au vendredi de 9h00 jusqu'à 17h30 Heure de l'est. Si vous résidez à l'extérieur des États-Unis ou Canada veuillez contacter immédiatement votre revendeur et lui expliquer votre problème. Il vous donnera des renseignements applicables sans votre pays et comment obtenir des pièces de rechange ou une assistance technique pour le montage de produits fabriqués par INVAL.

Inval America LLC | [www.invalamericallc.com](http://www.invalamericallc.com)

Toll Free/Sin-Cargos/Sans-Frais USA/Canada: 1-888-659-3512 x 178 | Fax: 1-888-901-0088

[sales@invalamerica.com](mailto:sales@invalamerica.com) | [customerservice@invalamerica.com](mailto:customerservice@invalamerica.com)

### Five (5) Year Limited Warranty United States of America and Canada

#### Thank you for your purchase of an INVAL product!

We are confident you will appreciate the fine quality and craftsmanship of your selection. INVAL stands proudly behind each and every product we manufacture and we guarantee our work through the following five (5) year limited warranty. We appreciate your business and look forward to your business in the years ahead.

In order to provide you with timely assistance, please thoroughly inspect your furniture for missing or damaged parts immediately after opening the carton. To receive replacement or missing part(s) under this warranty, call our Consumer Service Department, TOLL FREE, at 1-888-659-3512 x178, fax 1-888-901-0088 or contact us via e-mail: [customerservice@invalamerica.com](mailto:customerservice@invalamerica.com). Please have the Model and Part Number, found in the Instruction Sheet, available for your reference. You will also need your sales receipt or other proof of purchase. Replacement part(s) will be shipped to you at no charge with INVAL assuming all shipping and handling charges. All INVAL products are warranted to the end user at the time of purchase and for a period of five (5) years thereafter.

We warrant to you, the original purchaser, that our furniture and all of its parts and components are free of defects in material or workmanship. "Defects" as used in this warranty, is defined as any imperfections which impair the use of the furniture or product.

Our warranty is expressly limited to the replacement or furniture parts and components. For five (5) years after the date of purchase, INVAL will replace any part described on the enclosed Furniture Parts List that is defective in material or workmanship.

This warranty applies under conditions of normal use. Our furniture products are not intended for outdoor use. The warranty does not cover: 1) defects caused by improper assembly or disassembly; 2) defects occurring after purchase due to product modification, intentional damage, accident, misuse (including without limitation improper moving or sliding), abuse, negligence or exposure to the elements; 3) cosmetic damage; or 4) labor or assembly costs.

EXCEPT AS PROVIDED HEREIN, INVAL MAKES NO EXPRESS WARRANTIES, AND ANY IMPLIED WARRANTY, INCLUDING WITHOUT LIMITATION AN IMPLIED WARRANTY OR MERCHANTABILITY OR FITNESS FOR A PARTICULAR PURPOSE, IS LIMITED IN ITS DURATION TO THE DURATION OF THE WRITTEN LIMITED WARRANTY SET FORTH HEREIN.

Except as provided herein, INVAL shall have no liability or responsibility to the purchaser or any other person or entity with respect to any liability, loss of damage caused or alleged to be caused directly or indirectly by use of the product, including, but not limited to, any incidental or consequential damages, some states do not allow limitation on how long an implied warranty lasts or the exclusion of limitation of incidental or consequential damages, so the above limitation and exclusion may not apply to you.

This warranty gives you specific legal rights. You may have other rights which vary from state to state.

### Cinco (5) Años de Garantía al Consumidor Estados Unidos de América y Canadá

#### ¡Gracias por su compra de este producto INVAL!

Esperamos usted sepa apreciar la calidad y artesanía de este producto. INVAL orgullosamente respalda los productos que fabricamos y por ello los garantizamos por un periodo de cinco (5) años después de la fecha de su compra.

Nuevamente, nuestras expresivas gracias por haber seleccionado nuestros productos esperamos verlos favorecidos con sus futuras compras.

Para asistirle con mayor rapidez, por favor, revise cuidadosamente todas las piezas de este productor y así detectara faltas o piezas dañadas inmediatamente después de abrir el empaque. Si usted reside en los Estados Unidos o Canadá comuníquese de inmediato con nuestro Departamento de Servicio al Consumidor 1-888-659-3512 x 178, fax 1-888-901-0088 o vía correo electrónico [customerservice@invalamerica.com](mailto:customerservice@invalamerica.com) y recibirá, sin costo alguno para usted, las piezas defectuosas o faltantes. Por favor tenga a mano el número del modelo y el número de la parte o pieza que usted necesita. Esta información la encontrará en el manual de instrucciones que acompaña a su mueble.

También necesitará tener a mano la factura o recibo de compra. Los repuestos que usted necesite se les enviarán directamente a donde usted nos indique sin costo ninguno para usted, dentro de Estados Unidos o Canadá.

Todos los productos fabricados por INVAL están garantizados al usuario final por un periodo de cinco (5) años después de la fecha de su compra.

Le garantizamos, al consumidor original, que nuestros muebles así también como sus partes y/o otros componentes no tienen materiales defectuosos o defectos en su manufactura. La palabra "Defecto" se define en esta garantía específicamente a imperfecciones que le impidan el uso de este mueble al consumidor original.

Esta garantía está expresamente limitada a reemplazar las piezas y/o componentes que tengan defectos en su manufactura durante un periodo de cinco (5) años después de la fecha de su compra.

Esta garantía será aplicable solamente cuando se le dé un uso normal a este mueble por el consumidor. Estos productos no han sido diseñados ni fabricados para ser usados a la intemperie. Esta garantía no sobre: 1) defectos que hayan sido causados por ensamblaje defectuoso, 2) defectos que ocurran después que usted haya comprado el producto y le haga cualquier codificación, roturas intencionales, accidentes, abuso, uso indebido, negligencia o que sean expuestos a inclemencias climatológicas, 3) daños en su apariencia y 4) costo de mano de obra por ensamblaje.

EXCEPTUANDO LO ANTES DICHO, INVAL NO OFRECE OTRAS GARANTIAS ESPECIFICAS O INSINUADAS, IGUALMENTE NO GARANTIZAMOS LA COMERCIALIZACION DE ESTE PRODUCTO O QUE EL MISMO SEA APTO PARA EL USO ESPECIFICO QUE USTED DESEA, ADEMÁS EL PERIODO DE ESTA GARANTIA ESTA MILITADO AL TIEMPO ARRIBA INDICADO.

Exceptuando lo antes dicho, INVAL no asume ninguna responsabilidad legal con el consumidor, o cualquiera otra persona, entidad comercial con respecto a pérdidas o daños que sean a causa o que se alegue sean causa directa o indirecta del uso de este producto, incluyendo, pero no limitado a accidentes o daños consecuentes. En algunos estados de E.U.A no reconocen las limitaciones arriba mencionadas, por lo tanto, las mismas quedan sin efecto.

Esta garantía le da a usted derechos legales específicos. Usted también pudiese tener otros derechos dependiendo de las leyes y regulaciones del lugar donde usted resida.

### Garantie Limitée de Cinq (5) Ans États-Unis ou Canada

#### Merci d'avoir fait l'acquisition d'un produit fabriqué par INVAL

Nous sommes certains que vous apprécierez la qualité et le travail qui a été apporté à la fabrication du produit que vous venez de choisir. Chez INVAL, nous répondons de chacun de nos produits et garantissons ces derniers avec une garantie limitée de cinq (5) ans. Nous sommes flattés de votre choix et espérons pouvoir répondre à vos besoins futurs au cours des prochaines années.

Afin de vous servir au mieux, veuillez vérifier votre meuble afin de vous assurer qu'aucune pièce ne s'avère manquante ou endommagée immédiatement après l'ouverture du carton. Afin d'obtenir des pièces de rechange ou les pièces manquantes couvertes par la garantie, appelez notre service après-vente San Frais au 1-888-659-3512 x 178, fax 1-888-901-0088 ou contactez-nous par l'intermédiaire de [customerservice@invalamerica.com](mailto:customerservice@invalamerica.com) Veuillez soumettre le nom et le numéro du modèle que vous trouverez sur la feuille d'instruction fournie en tant que référence. Vous aurez également besoin de votre reçu de vente ou de toute autre preuve d'achat. La ou les pièces de rechange vous seront envoyées gratuitement. INVAL se chargera des frais d'expédition et de manutention.

Chaque produit fabriqué par INVAL est garanti pendant cinq (5) ans à partir de la date d'achat. Cette garantie est limitée à l'acheteur initial.

Nous garantissons à l'acheteur d'origine que nos meubles et leurs pièces ne présentent aucun vice de matériau et de fabrication. Le terme « Défaut » ou « Vice » utilise dans cette garantie signifie une imperfection risquant de gêner ou d'empêcher toute utilisation du meuble.

Notre garantie est expressément limitée au remplacement des pièces du meuble et de ces composants. INVAL s'engage à remplacer toute pièces indiquée sur la liste des pièces du meuble présentant un vice de matériau ou de fabrication pendant une durée de cinq (5) ans.

Cette garantie s'applique dans des conditions d'une utilité normale. Nos produits de meubles ne sont pas prévus pour l'usage extérieur. La garantie ne couvre pas : 1) défauts provoqués par l'assemblée ou le démontage inexacte ; 2) défauts se produisant après l'achat du a la modification de produit, aux dommages intentionnels, a l'accident, a l'abus (y compris sans de déplacer inexact de limitation ou glissant), a l'abus, a la négligence ou à l'exposition aux éléments ; 3) dommages cosmétiques ; ou 4) courts de travail ou d'assemblage.

A L'EXCEPTION DES TERMES DE LA PRESENTE, INVAL NE FORMULE AUCUNE GARANTIE EXPRESSE ET TOUTE GARANTIE IMPLICITE Y COMPRIS TOUTE GARANTIE IMPLICITE D'APTITUDE A LA COMMERCIALIZATION ET D'APTITUDE A UN USAGE PARTICULIER EST LIMITEE A LA PERIODE DE VALIDITE DE LA GARANTIE LIMITEE.

A l'exception des termes de la présente, INVAL décline toute responsabilité en cas de responsabilité, perte, dégâts découlant ou prétendant découler directement ou indirectement de l'utilisation du produit, y compris mais non limite aux dommages accessoires et consécutifs. Certains états ne permettent pas la limitation en durée d'une garantie implicite ni l'exclusion de la limitation de dommages directs ou indirects. Par conséquent, les exclusions ou limitations indiquées ci-dessus peuvent ne pas vous être applicables.

Cette garantie vous donne des droits juridiques spécifiques, Il est possible que vous ayez d'autres droits variant d'un état à l'autre.

**-This instruction manual contains important information. Follow the consecutive order.  
Please read and keep for future reference.**

**-Este Manual contiene información importante. Siga el orden consecutivo de las instrucciones.  
Por favor léalo y guárdelo para consultas en el futuro.**



Two or more people are required to assemble and/or move this unit.  
Se requiere de dos o más personas para armar y mover este mueble.



Unpack and assemble this unit in an spacious area. Assemble the unit on top of the empty box to prevent scratches.  
Desempaque y arme este mueble en un area espaciosa. Arme el mueble sobre su caja, para no rayarlo.



Protect furniture from water and moisture. This furniture must not be used outdoors.  
Proteja el mueble del agua y de la humedad. No ubique este mueble al aire libre.



Do not expose it to heat.  
No lo exponga al calor.



Do not hit or tap with a hammer, unless it is indicated.  
No lo golpee ni lo martille.



Do not paint or use abrasive elements to clean this furniture.  
No pinte ni use elementos abrasivos para limpiar este mueble.



Do not drag or climb on your furniture. If you need to move it, lift it.  
No lo arrastre ni se suba al mueble. Si necesita moverlo, levántelo.

## TOOLS REQUIRED HERRAMIENTAS REQUERIDAS

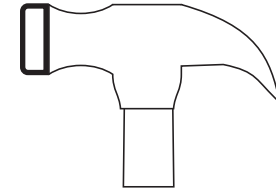

**HAMMER/  
MARTILLO**

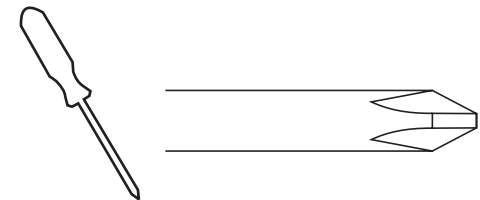

**PHILLIPS SCREWDRIVER /  
ATORNILLADOR DE ESTRELLA**

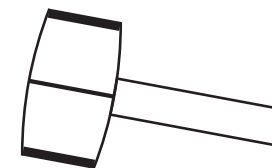

**RUBBER  
HAMMER/  
MARTILLO  
DE GOMA**

**IMPORTANT:** Before proceeding to assemble this unit, read the instructions and inspect carefully the parts and hardware thoroughly.  
If any part is missing, do not return to the store, please call toll free: 1 888 659 3512 , Xt. 178 In the USA, Canada, Puerto Rico and US Virgin Islands visit our Web page [www.invalamerica.com](http://www.invalamerica.com).

**IMPORTANTE:** Antes de empezar a ensamblar este mueble, lea este instructivo y revise cuidadosamente las piezas y herrajes.  
En caso de que le haga falta alguna pieza, no lo devuelva a la tienda, favor llamar a la línea gratuita 1 888 659 3512 , Xt. 178 en Colombia para USA, Canada, Puerto Rico y US Virgin Islands visite nuestra página Web [www.invalamerica.com](http://www.invalamerica.com).

# PARTS IDENTIFICATION/IDENTIFICACIÓN DE PIEZAS

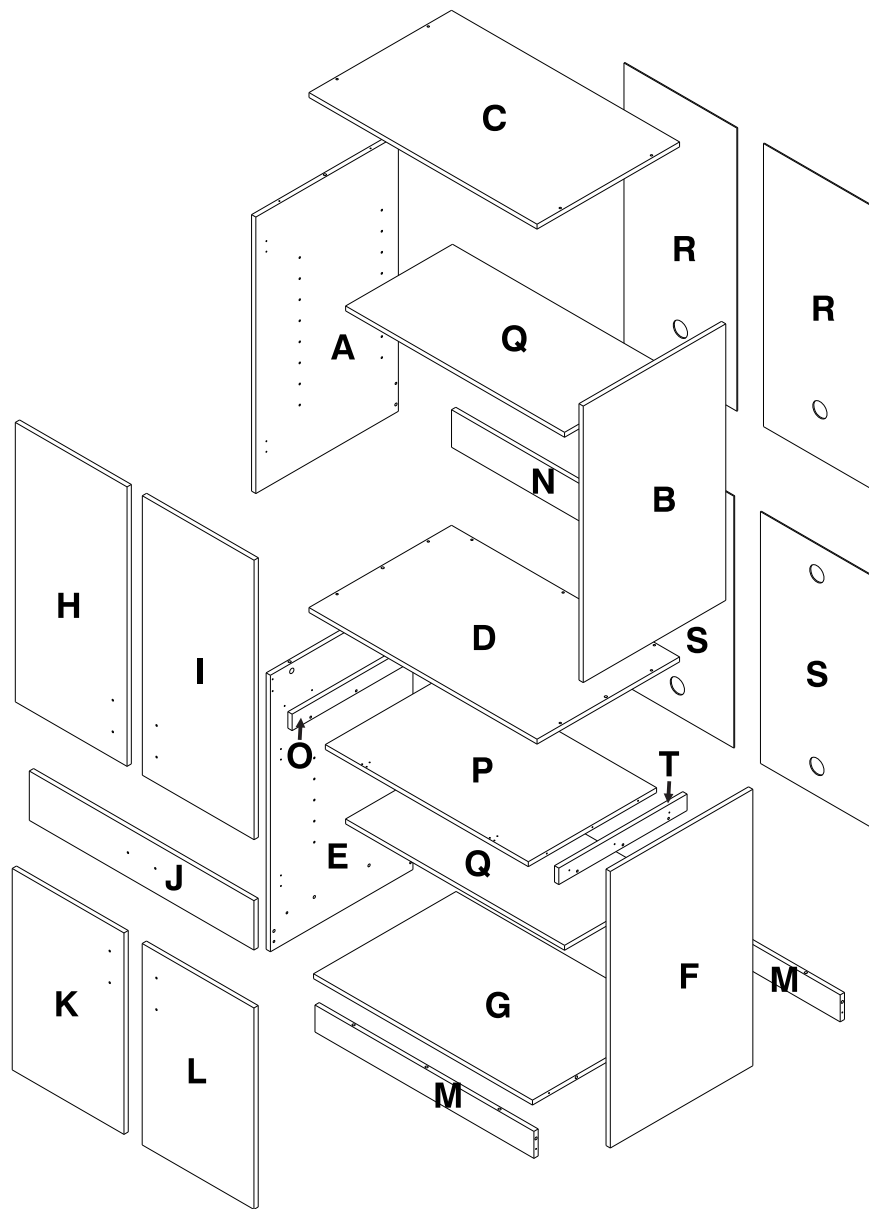









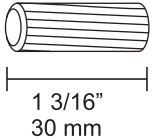
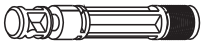
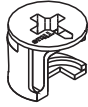
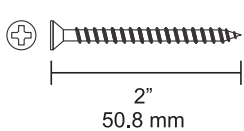
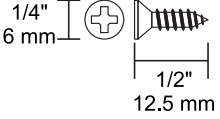
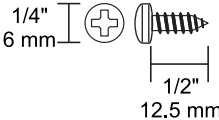
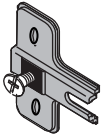
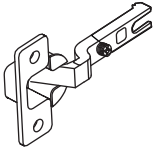
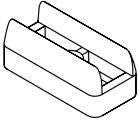
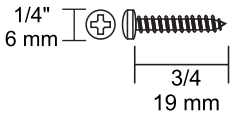
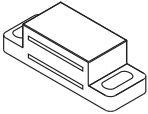

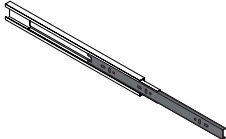
PIEZA PARTS	CANTIDAD QUANTITY
A	1
B	1
C	1
D	1
E	1
F	1
G	1
H	1
I	1
J	1
K	1
L	1
M	2
N	1
O	1
P	1
Q	2
R	2
S	2
T	1

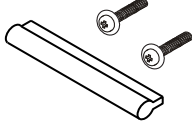
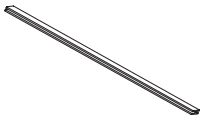
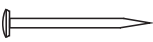
QUANTITY/ CANTIDAD	FROM/ DESDE	TO/ HASTA
24	A	T

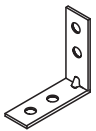
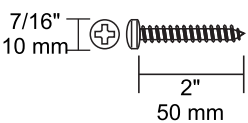

# HARDWARE IDENTIFICATION/IDENTIFICACIÓN DE HERRAJES

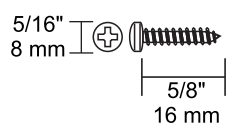
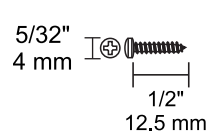
<p>① WOODEN DOWELS/ TARUGOS MADERA</p>  <p>X 22</p>	<p>② CAM STUDS/ PERNOS</p>  <p>X 4</p>	<p>③ CAMS LOCKS/ TUERCAS</p>  <p>X 4</p>	<p>④ BLACK SCREWS/ TORNILLO NEGRO</p>  <p>X 27</p>	<p>⑤ TRAY HINGE SCREWS/ TORNILLO BISAGRA</p>  <p>X 12</p>
<p>⑥ HINGE SCREW/ TORNILLOS BISAGRA</p>  <p>X 44</p>	<p>⑦A HINGE/ BISAGRA</p>  <p>X 8</p>	<p>⑦B DOOR HINGE/ BISAGRA PUERTA</p>  <p>X 8</p>	<p>⑧ GLIDERS/ DESLIZADORES</p>  <p>X 4</p>	<p>⑨ GLIDER SCREW/ TORNILLO DESLIZADOR</p>  <p>X 4</p>
<p>⑩ MAGNET/ IMAN</p>  <p>X 2</p>	<p>⑪ MAGNETIC PLATE/ PLATINA IMAN</p>  <p>X 2</p>	<p>⑫ FULL EXTENSION SLIDES/ CORREDERAS FULL EXT.</p>  <p>X 2</p>	<p>⑬ KEYBOARD HINGE/ BISAGRA PORTATECLADO</p>  <p>X 2</p>	<p>⑭ HANDLE AND SCREW/ MANIJA Y TORNILLO</p>  <p>X 5</p>
<p>⑮ PLASTIC BEVEL/ BISEL PLASTICO</p>  <p>X 2</p>	<p>⑯ NAILS/ PUNTILLAS</p>  <p>X 40</p>	<p>⑰ SCREW CAPS/ TAPA TORNILLO</p>  <p>X 10</p>	<p>⑱ PANEL SUPPORTS/ SOPORTES ENTREPAÑOS</p>  <p>X 8</p>	<p>⑲ STAR WASHERS/ ARANDELA DE ESTRELLA</p>  <p>X 7</p>
<p>⑳ WALL BRACKET/ ESCUADRA DE PARED</p>  <p>X 1</p>	<p>㉑ WALL SCREW/ TORNILLO PARED</p>  <p>X 1</p>	<p>㉒ WALL ANCHOR/ CHAZO ANCLAJE PARED</p>  <p>X 1</p>	<p>㉓ SCREW/ TORNILLO</p>  <p>X 1</p>	<p>㉔ MAGNET SCREW/ TORNILLO IMAN</p>  <p>X 4</p>

# HARDWARE IDENTIFICATION/IDENTIFICACIÓN DE HERRAJES

25 MAGNETIC PLATE SCREW/  
TORN. PLATINA IMÁN

X  
4

## ASSEMBLY SUGGESTIONS / RECOMENDACIONES DE ENSAMBLE

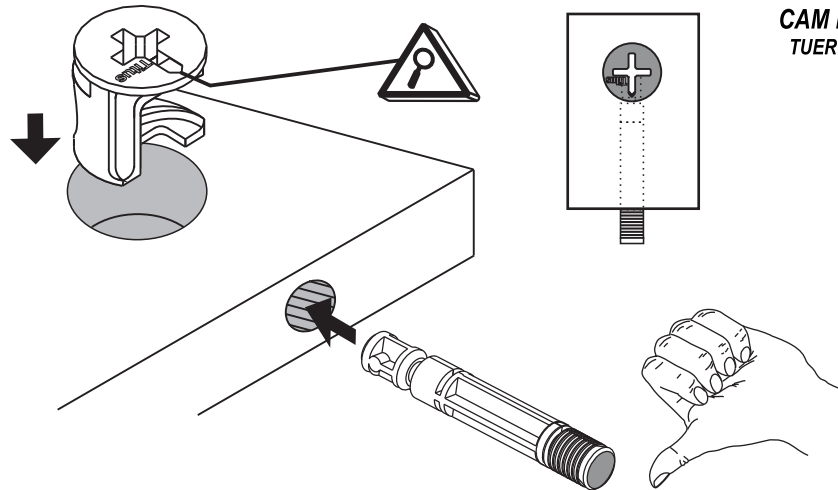

**CAM LOCKS AND CAM STUD**  
TUERCA Y PERNO DE EXPANSIÓN

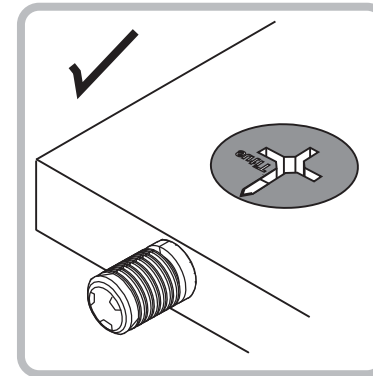

**SEPARATE / SEPARAR**  
FULL EXTENSION SLIDE/  
CORREDERA FULL EXTENSION

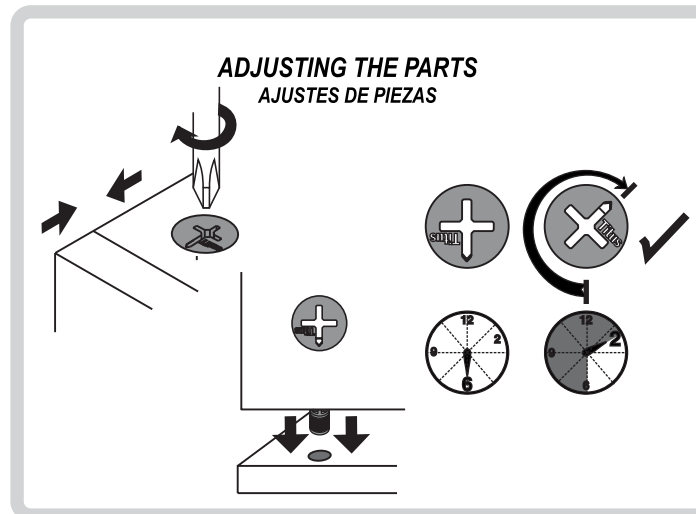
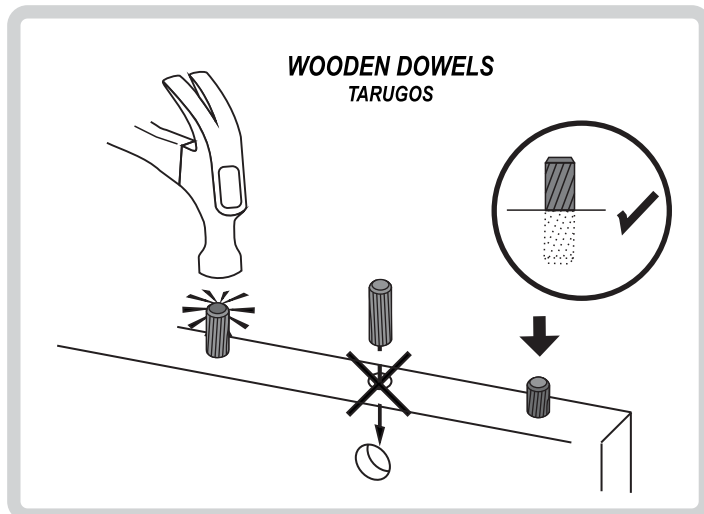
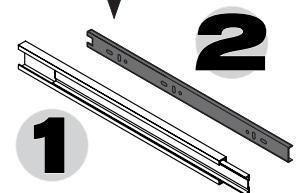
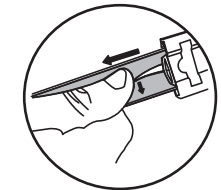
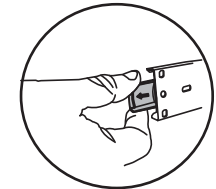
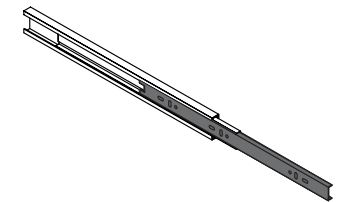

# PARTS PREPARATION / PREPARACIÓN DE PARTES

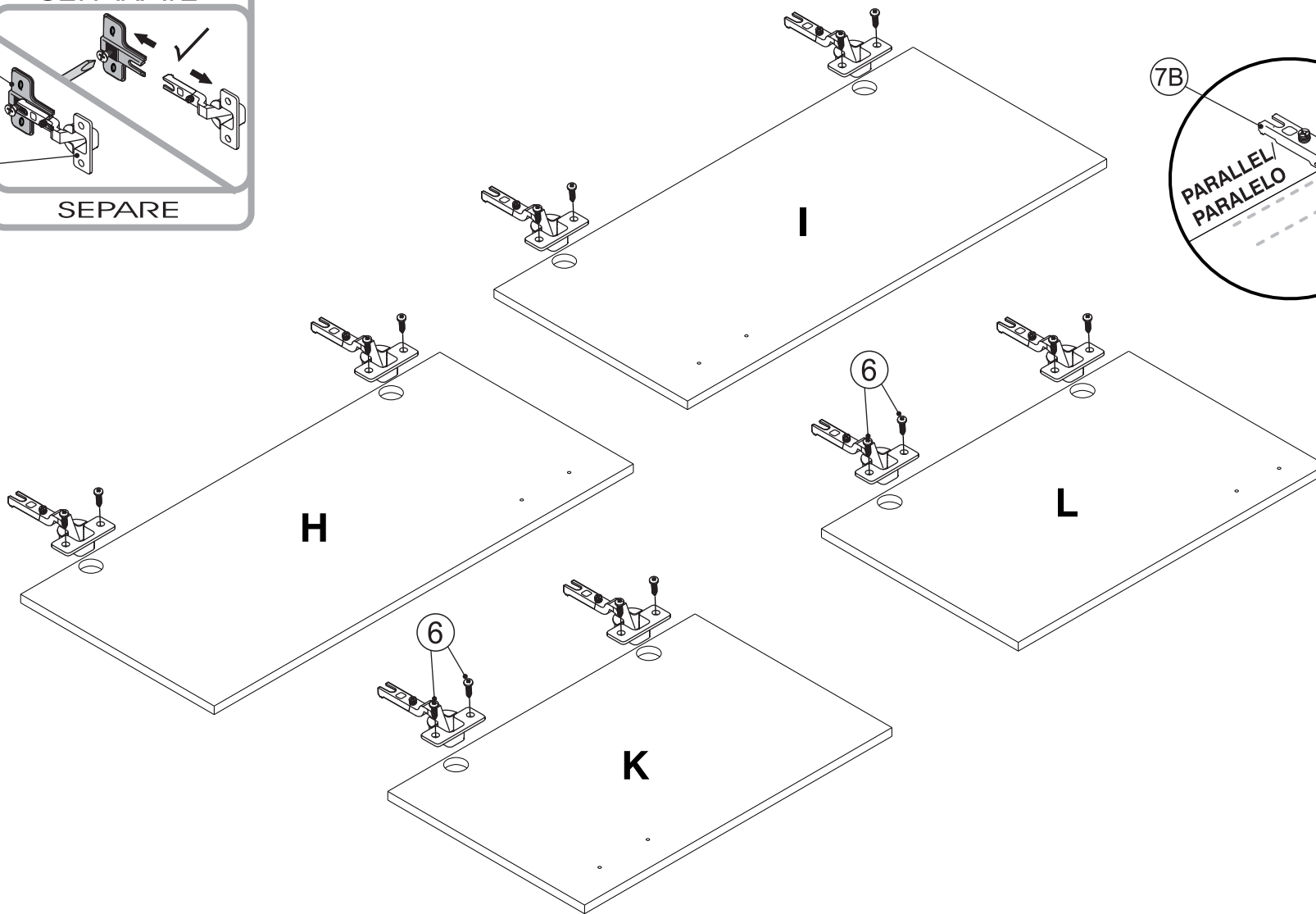
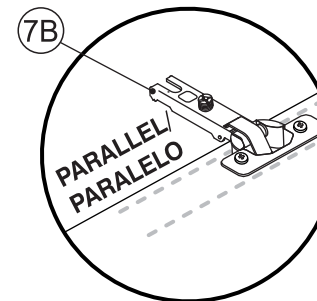
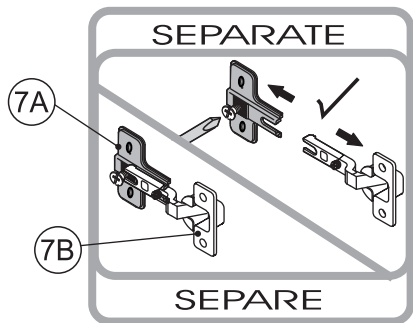

<b>7B</b>	DOOR HINGE/ BISAGRA PUERTA	<b>X</b>
		<b>8</b>

<b>6</b>	HINGE SCREW/ TORN. BISAGRA	<b>X</b>
		<b>16</b>

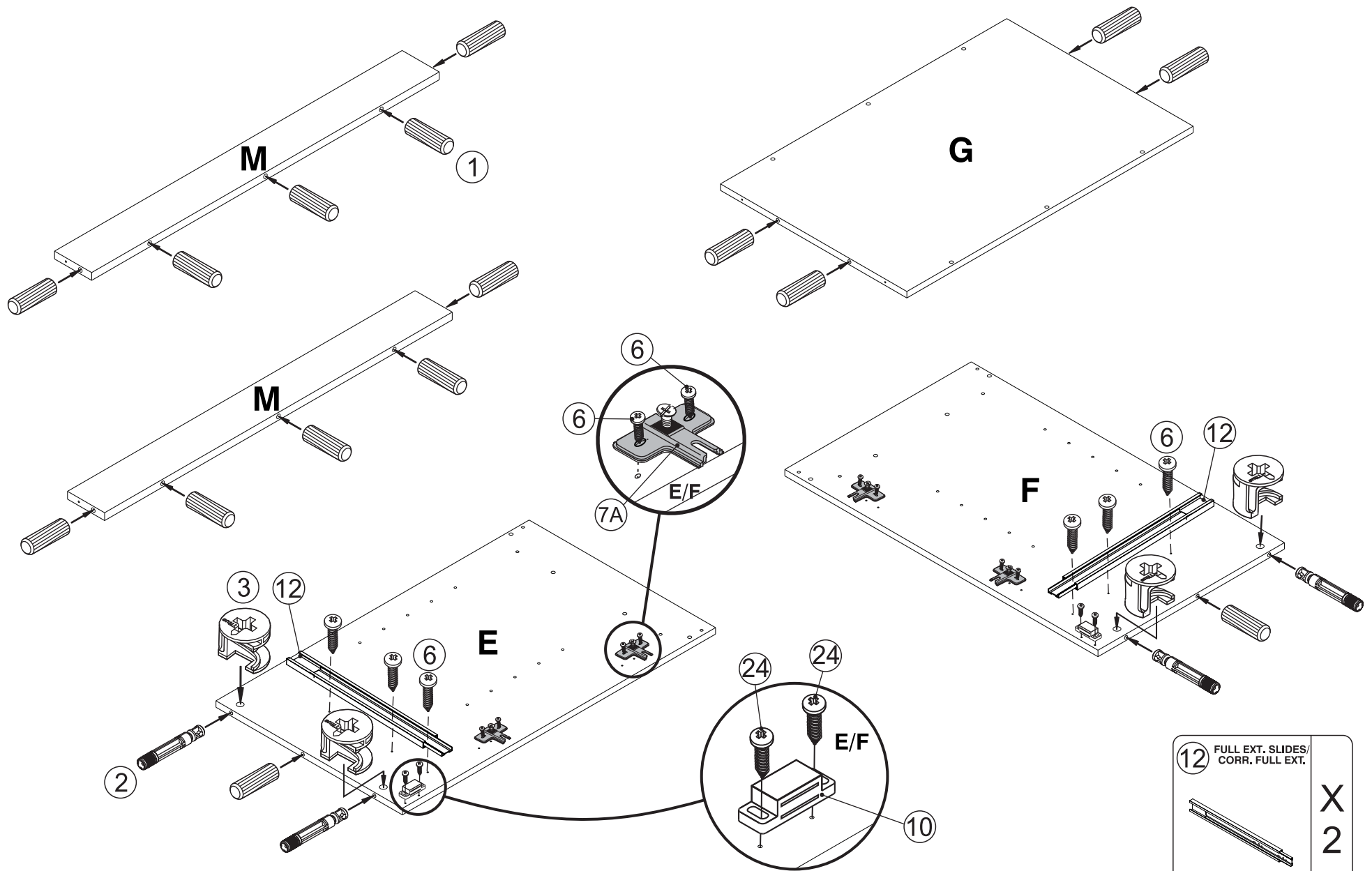

**1** WOODEN DOWELS/  
TARUGOS MADERA

**X**  
**16**

1 3/16"  
30 mm

**2** CAM STUDS/  
PERNOS

**X**  
**4**

**3** CAMS LOCKS/  
TUERCAS

**X**  
**4**

**6** HINGE SCREW/  
TORN. BISAGRA

**X**  
**14**

1/4"  
6 mm

1/2"  
12.5 mm

**7A** HINGE/  
BISAGRA

**X**  
**4**

**10** MAGNET/  
IMAN

**X**  
**2**

**24** MAGNET SCREW/  
TORNILLO IMAN

**X**  
**4**

5/32"  
4 mm

1/2"  
12.5 mm

**12** FULL EXT. SLIDES/  
CORR. FULL EXT.

**X**  
**2**

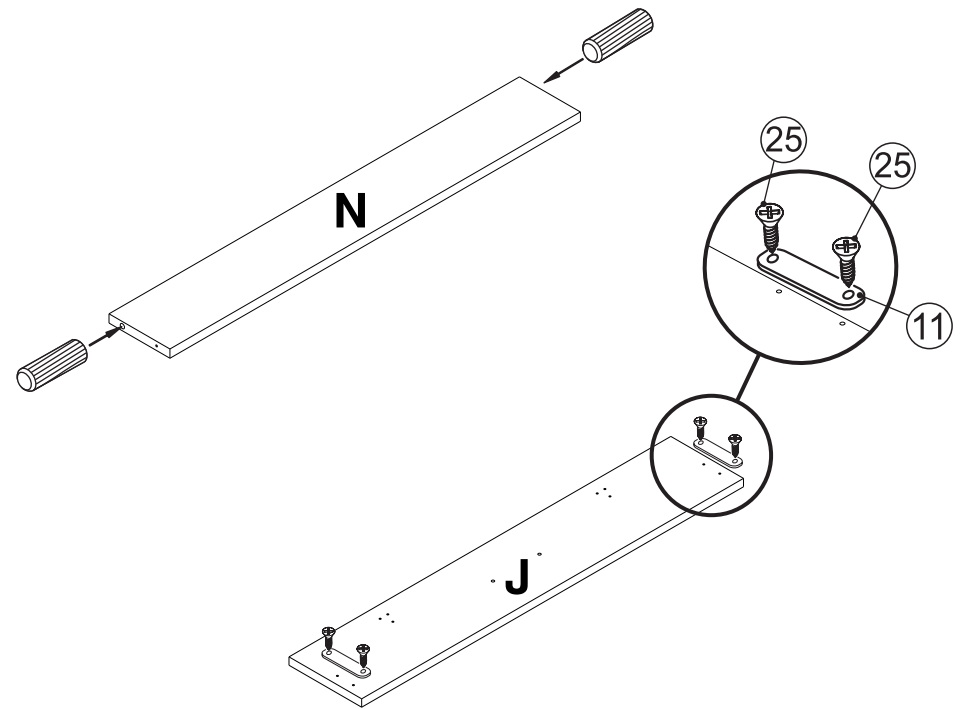
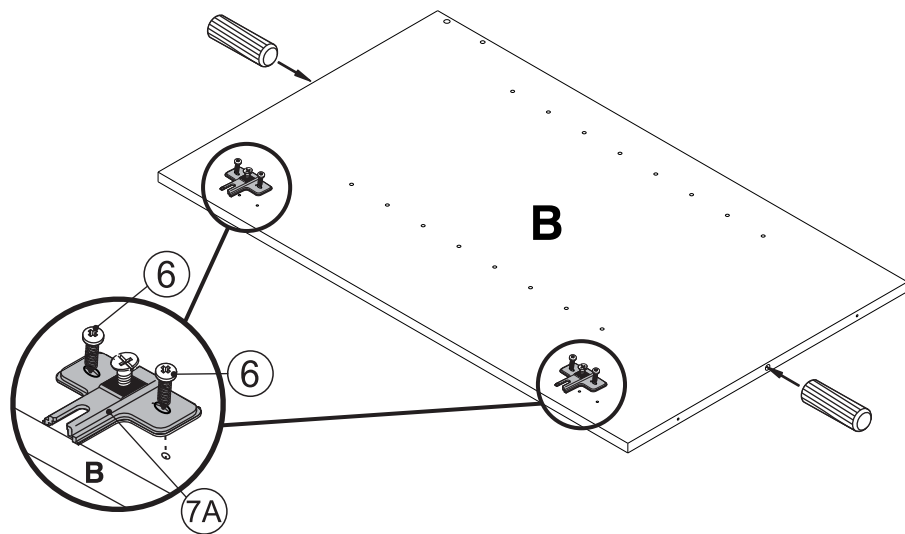
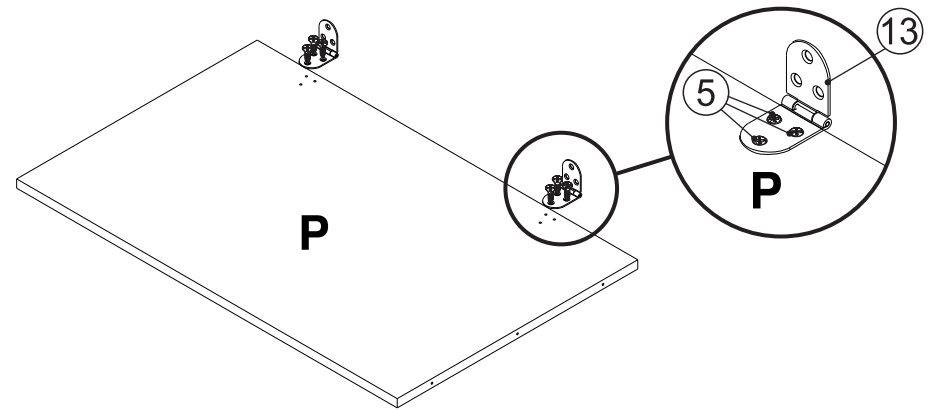
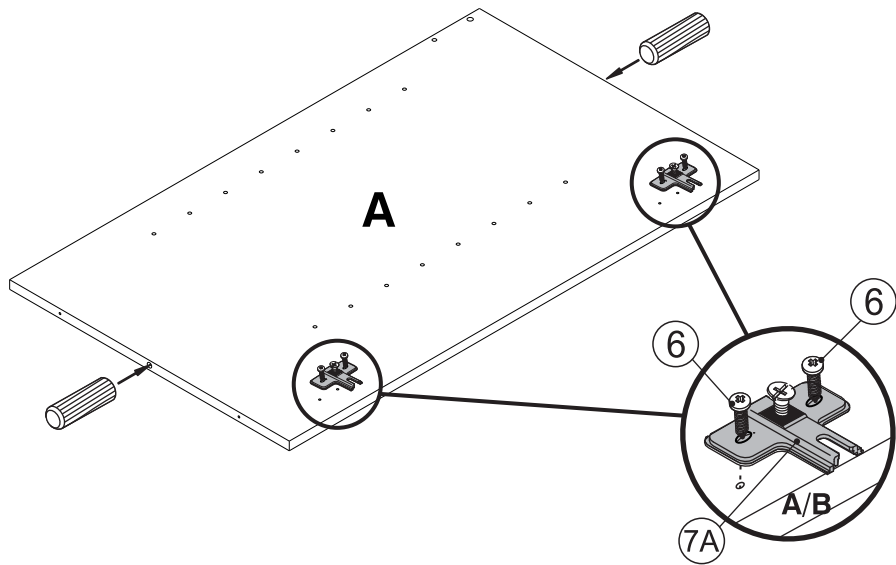

**1** WOODEN DOWELS/  
TARUGOS MADERA

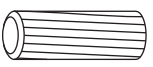

1 3/16"  
30 mm

X  
**6**

**6** HINGE SCREW/  
TORN. BISAGRA



1/4"  
6 mm

1/2"  
12.5 mm

X  
**8**

**7A** HINGE/  
BISAGRA

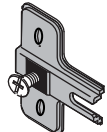

X  
**4**

**11** MAGNETIC PLATE/  
PLATINA IMÁN



X  
**2**

**25** PLATE SCREW/  
TORN. PLATINA



5/32"  
4 mm

1/2"  
12.5 mm

X  
**4**

**13** KEYBOARD HINGE/  
BISAGRA PORTAT.



X  
**2**

**5** HINGE SCREWS/  
TORNILLO BISAGRA



1/4"  
6 mm

1/2"  
12.5 mm

X  
**6**



**FURNITURE ASSEMBLY/  
ARMADO DEL MUEBLE**

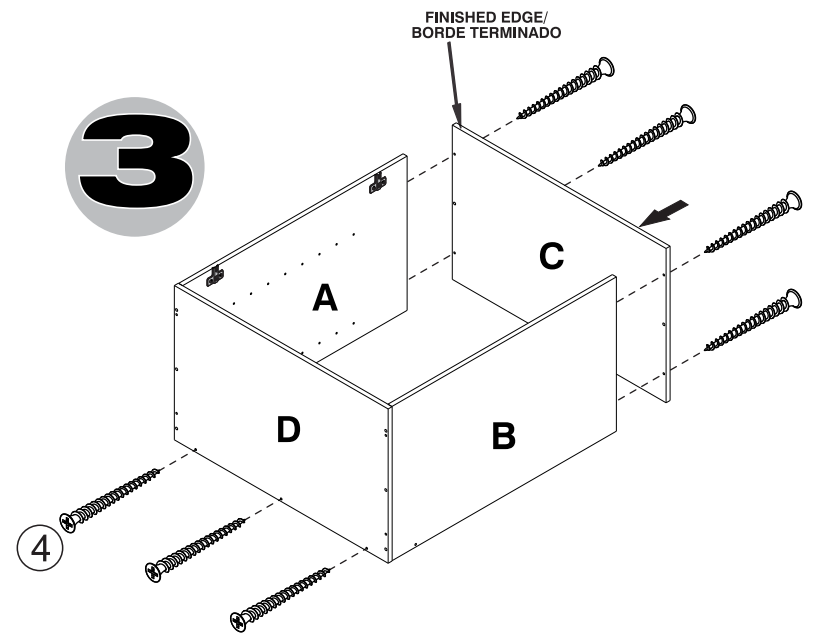
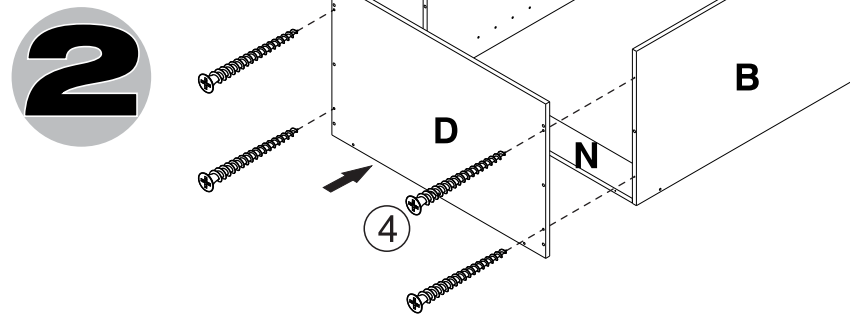
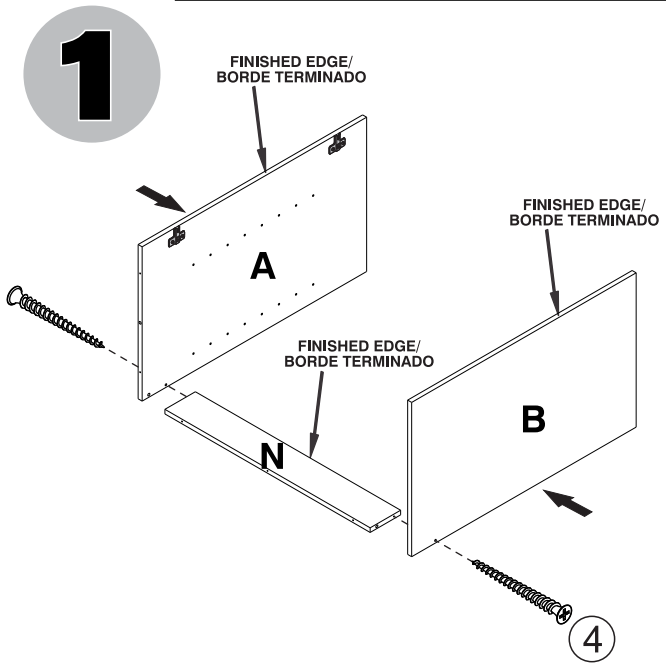

**SUGGESTION /**

**ASSEMBLE ON A FLAT  
AND CLEAN SURFACE  
TO AVOID DAMAGES./**  
ARME SOBRE UNA  
SUPERFICIE LIMPIA Y  
PLANA  
PARA EVITAR POSIBLES  
AVERIAS.

**SUGERENCIA**

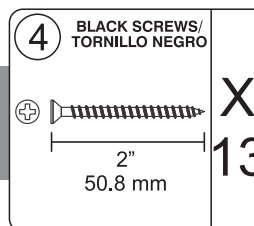

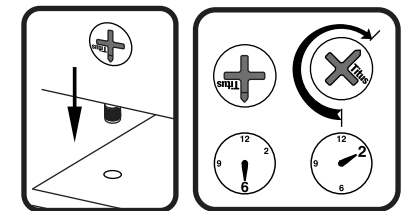
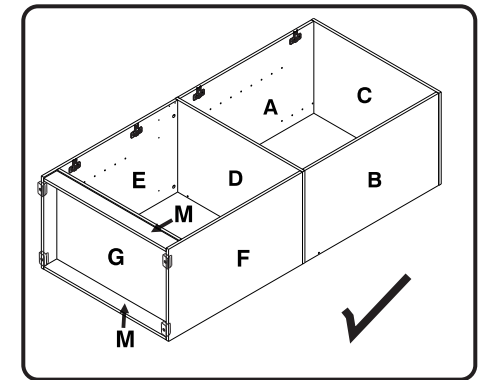
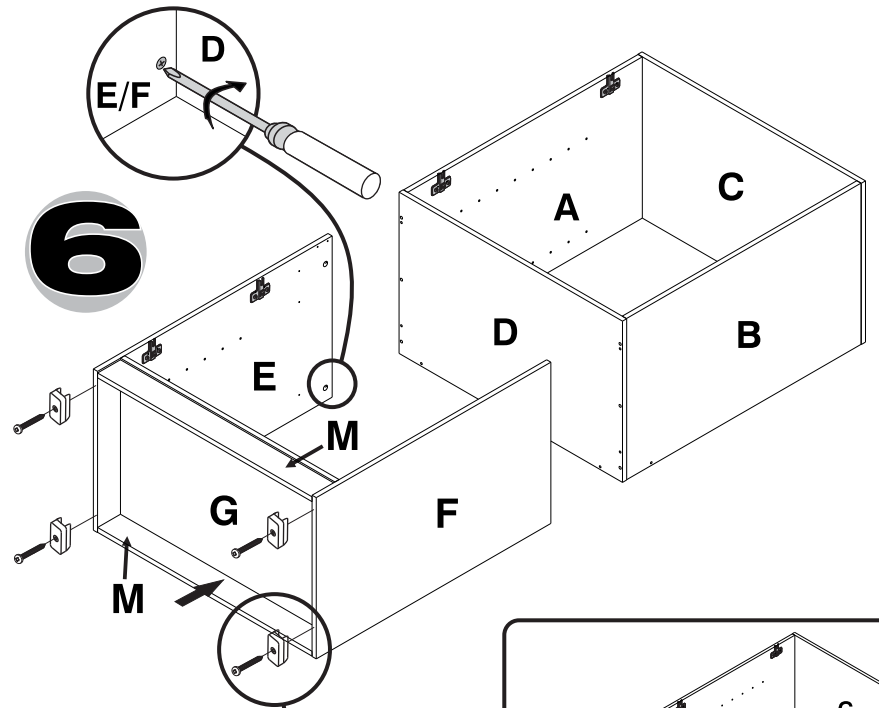
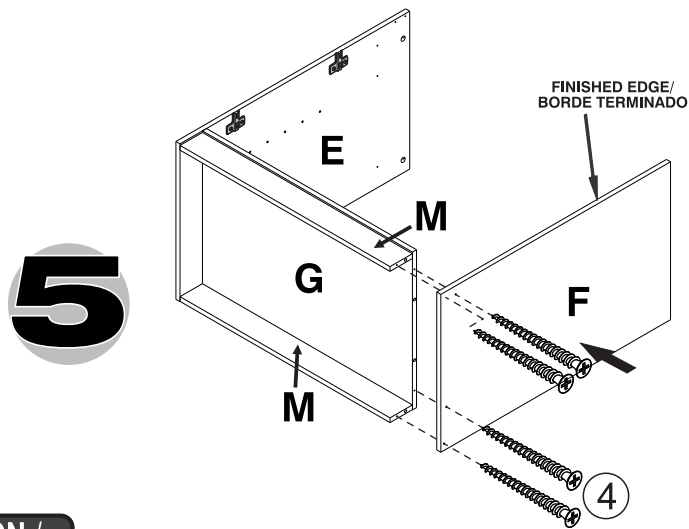
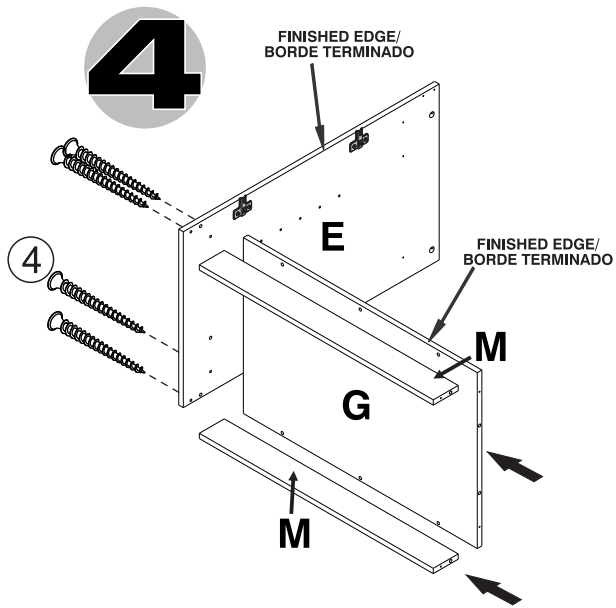

AFTER THE PARTS ARE CONNECTED,  
SCREW AS SHOWN



**SUGGESTION /**  
**ASSEMBLE ON A FLAT**  
**AND CLEAN SURFACE**  
**TO AVOID DAMAGES./**  
 ARME SOBRE UNA  
 SUPERFICIE LIMPIA Y  
 PLANA  
 PARA EVITAR POSIBLES  
 AVERIAS.  
**SUGERENCIA**

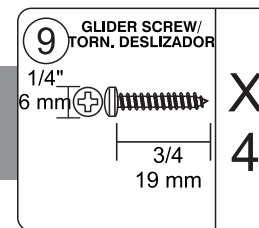
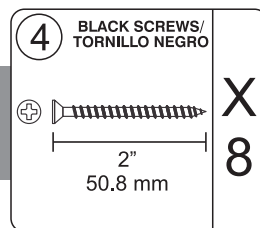

# 7

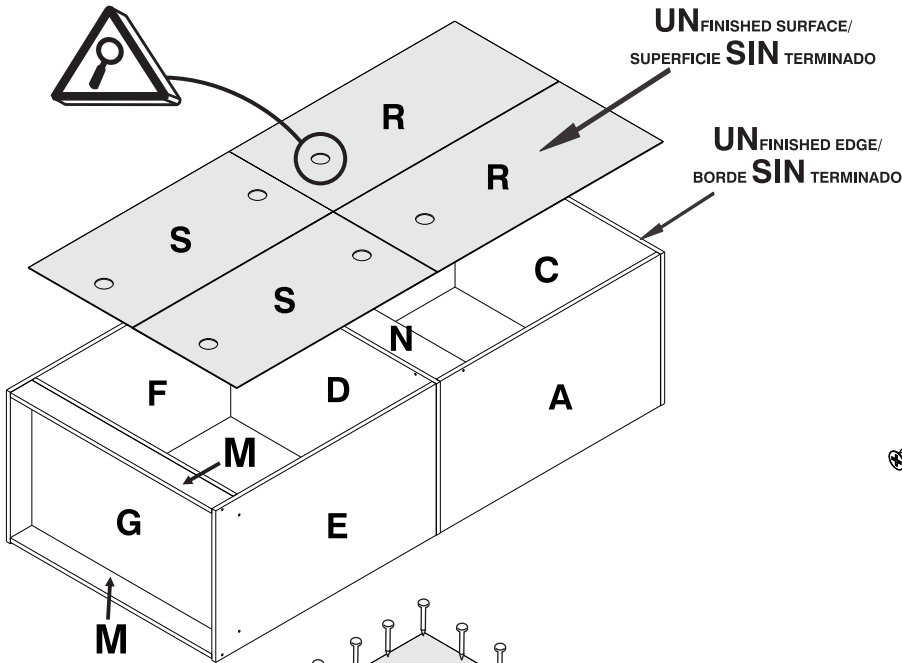
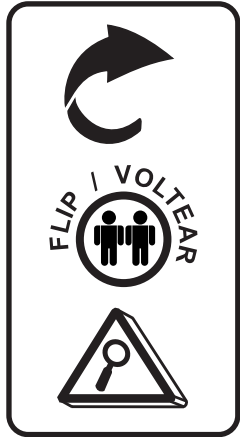

# 8

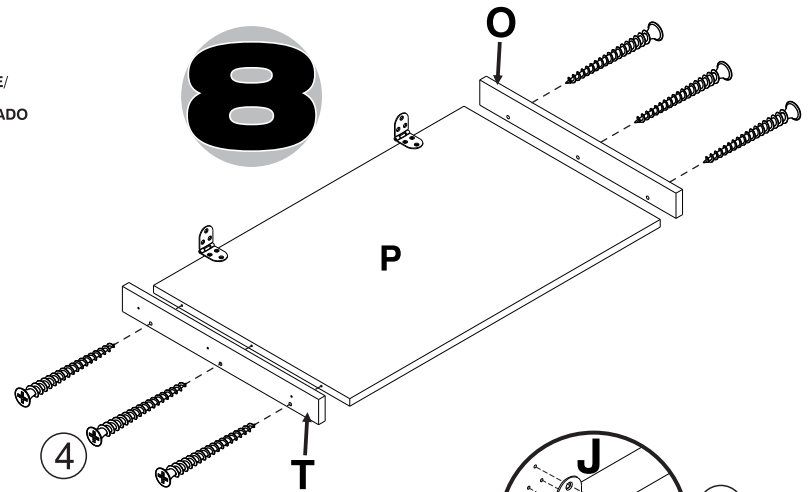

# 9

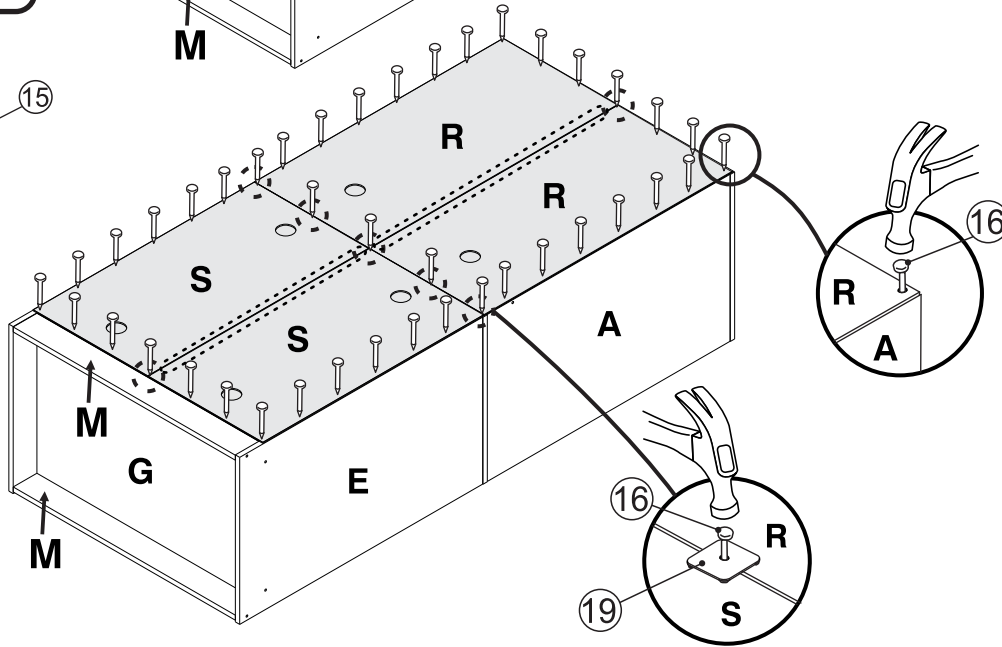
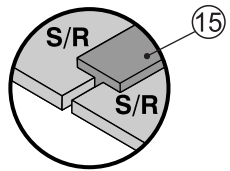
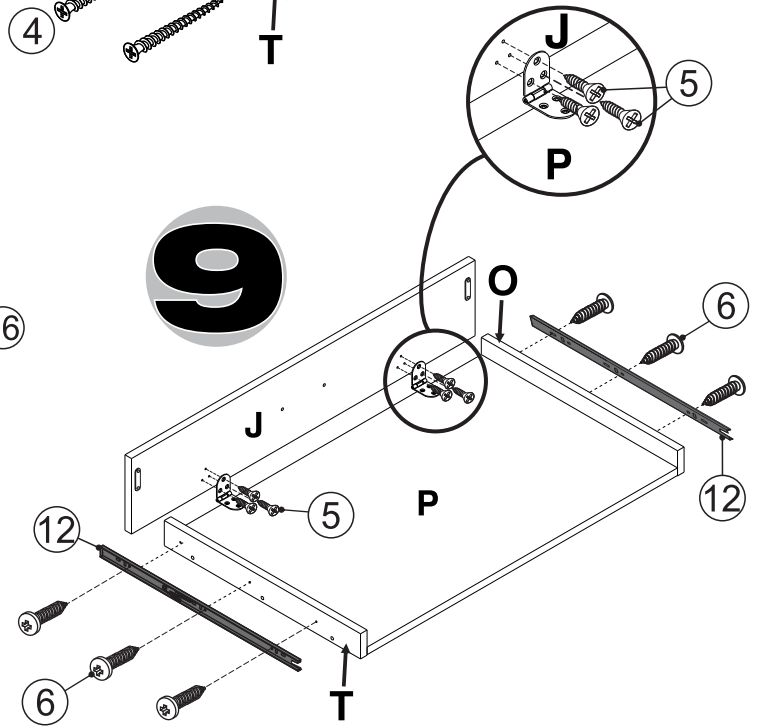

**4** BLACK SCREWS/  
TORNILLO NEGRO

2"  
50.8 mm

**X 6**

**15** PLASTIC BEVEL/  
BISEL PLASTICO

**X 2**

**16** NAILS/  
PUNTILLAS

**X 40**

**19** STAR WASHERS/  
ARANDELA

**X 7**

**5** HINGE SCREWS/  
TORNILLO BISAGRA

1/4"  
6 mm

1/2"  
12.5 mm

**X 6**

**6** HINGE SCREW/  
TORN. BISAGRA

1/4"  
6 mm

1/2"  
12.5 mm

**X 6**

**12** FULL EXT. SLIDES/  
CORR. FULL EXT.

**X 2**



# 10

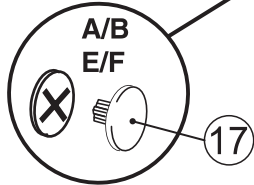
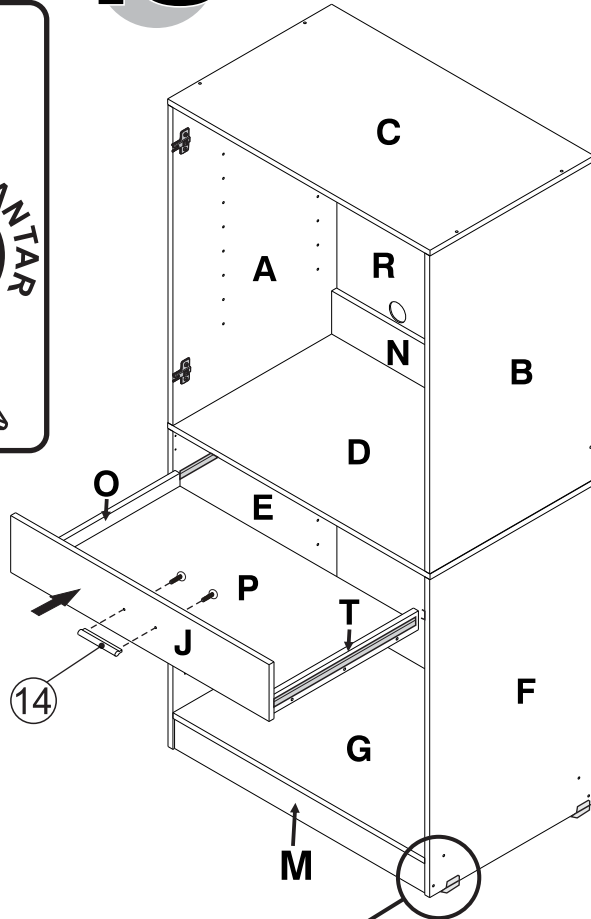

# 11

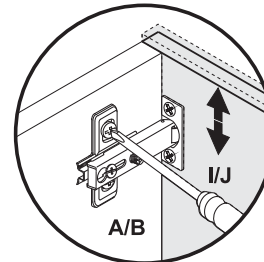
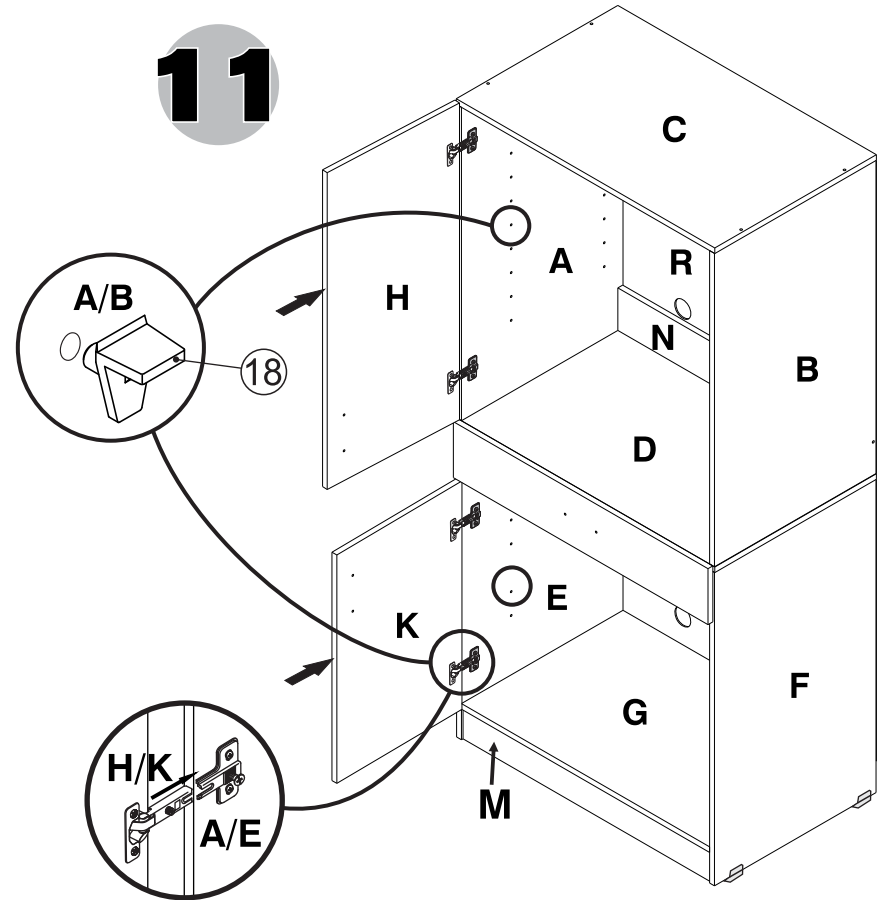

HEIGHT ADJUSTMENT  
AJUSTE DE ALTURA

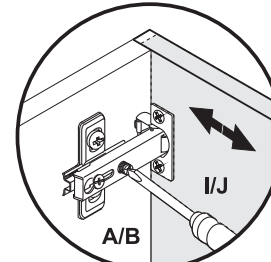

LATERAL ADJUSTMENT  
AJUSTE LATERAL

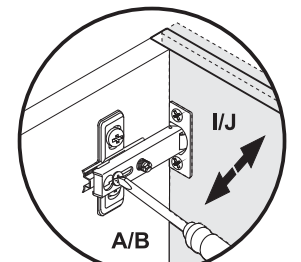

DEPTH ADJUSTMENT  
AJUSTE DE PROFUNDIDAD

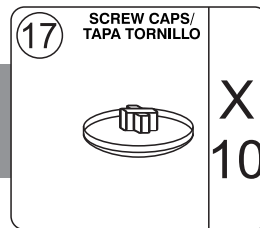
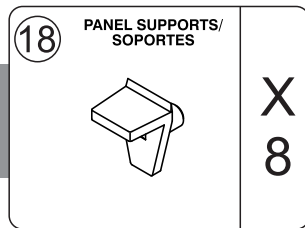
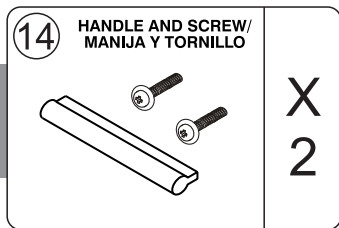

For the use of this type of anchor, the walls must be made of solid concrete and brick. If not, contact your nearest hardware store./

Para el uso de este chazo de anclaje las paredes deben ser solidas, de cemento y ladrillo. Si no, contáctese con su ferretería más cercana.

# 12

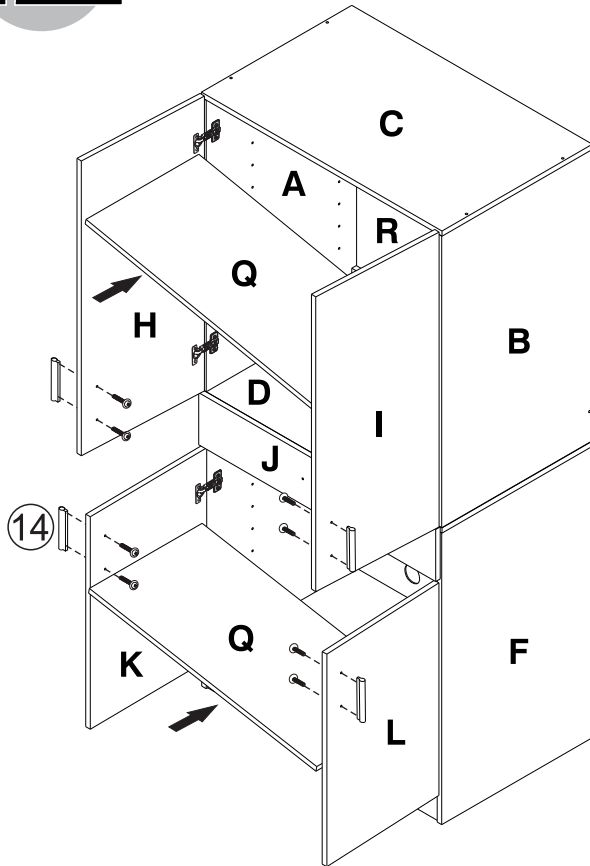

WALL / MURO

# 13

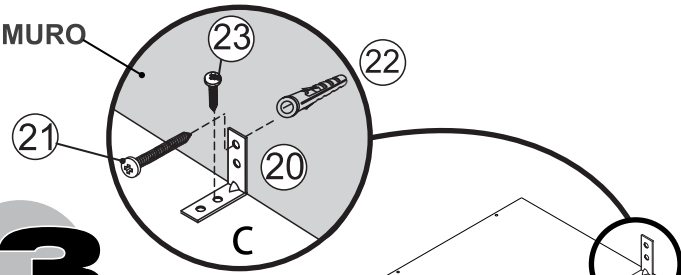

- Drill a 3/16" diameter hole (5mm) in the wall.
- Tap the wall anchor (#22) into the hole until it is flush.
- Fasten the wall bracket (#20) to the wall anchor (#22) with the screw (#21).
- Fasten the furniture with screw (#23) to the wall bracket (#20).

- Taladre un agujero de 3/16" de diametro (5mm) en la pared.
- Golpee la ancla de pared (#22) en el agujero hasta que quede parejo.
- Abroche la escuadra de pared (#20) al ancla de la pared (#22) con el tornillo (#21).
- Ancle el mueble con el tornillo (#23) a la escuadra # (20).

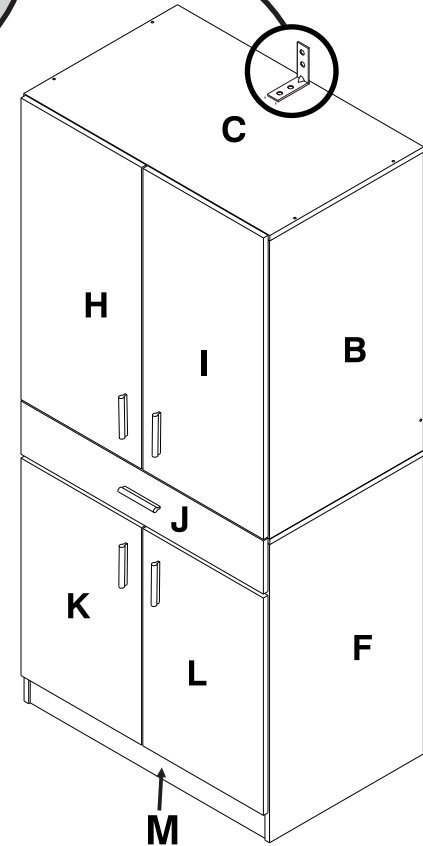
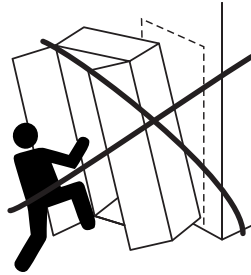

**CONGRATULATIONS!**, this way you finished assembling your furniture.

**¡FELICITACIONES!**, de esta manera usted termina de armar su mueble.

14	HANDLE AND SCREW/ MANIJA Y TORNILLO		X
			4

20	WALL BRACKET/ ESCUADRA DE PARED		X
			1

21	WALL SCREW/ TORNILLO PARED		X
			1

7/16" 10 mm

2" 50 mm

22	WALL ANCHOR/ CHAZO ANCLAJE PARED		X
			1

23	SCREW/ TORNILLO		X
			1

5/16" 8 mm

5/8" 16 mm