

YOGA

YOGA

AG

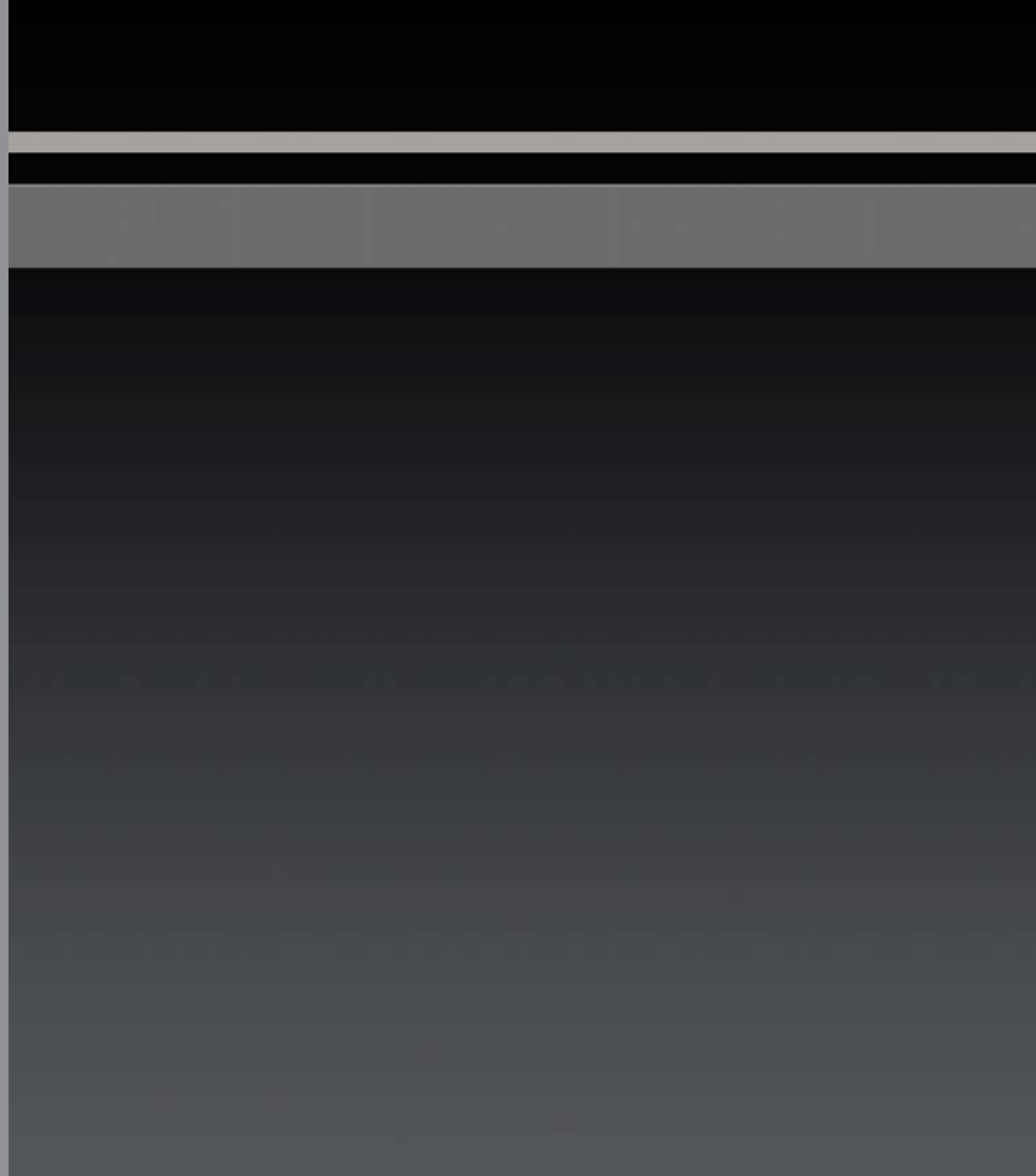





Y9

YOGA

AG

L'INSIEME DELLE TECNICHE CHE CONSENTONO IL CONGIUNGIMENTO DI CORPO, MENTE E ANIMA

per elevarsi al divino. La tecnica costruttiva del giunto in pressofusione di alluminio che consente il congiungimento tra elementi strutturali di servizio e superfici. Un "dettaglio" che caratterizza una raffinata e inusuale "cucitura" e crea una scrivania di forte personalità per tutte le necessità dell'ufficio di grande rappresentanza. Un'attenzione particolare ai materiali, alta riciclabilità degli stessi e rispetto dell'ambiente.

All the techniques which enable the union of body, mind and soul to rise the divine. The building technique of aluminium die-cast joint enabling the union between structural service elements and surfaces. A sort of "detail" that characterizes a refined and unusual "stitching" and creates a desktop with a strong personality for every kind of needs for a highly representative office. A particular attention to materials, high recycling ability of the same ones and environmental protection.

L'ensemble des techniques qui permettent la conjonction du corps, de l'esprit et de l'âme pour s'élever au divin. La technique de fabrication du joint en aluminium moulé sous pression qui permet la conjonction des éléments structurels de service et des surfaces. Un « détail » qui caractérise une « couture » raffinée et inhabituelle et qui crée un meuble de bureau avec une forte personnalité pour toutes les exigences d'un bureau de grande représentation. Une attention particulière accordée aux matériaux, à leur réutilisation et au respect de l'environnement.





UNA NUOVA VERSIONE DI TAVOLI IN PELLE PROTAGONISTI IN OGNI SPAZIO.

Un progetto caratterizzato dal grande contenitore portante e di servizio che crea un'isola di dimensioni extralarge dal forte sviluppo orizzontale: un paesaggio del confort in cui superfici e volumi compongono geometrie di grande originalità, attrezzate con ante scorrevoli e grandi vani a giorno.

A new collection of leather tables leading in any space. A project characterized by a large structural and service container, which creates a kind of extra-large island with a strong horizontal development: A comfort-oriented landscape in which surfaces and volumes make up extremely original layouts, equipped with sliding doors and large open compartments.

Une nouvelle collection de tables en cuir qui sont les protagonistes de tout les espaces. Un projet caractérisé par le grand meuble portant et de service qui crée un îlot de dimensions extra larges ayant un développement horizontal prononcé : un paysage de confort où les surfaces et les volumes composent des géométries vraiment originales, équipées de portes coulissantes et de grands compartiments ouverts.









YOGA, UNA NUOVA DIMENSIONE DELLA CONTEMPORANEITÀ:

progetto di interiors definiti da forme essenziali e materiali ricercati. Ricerca di purezza e tattilità. Le nuove superfici in vetro no-print conferiscono una piacevole sensazione al tatto ed eliminano l'effetto impronta sui piani e sulle ante ad apertura push&pull.

Yoga, a new dimension of contemporaneity: An interiors project defined by essential shapes and elegant materials. Pursuit of purity and tactility. The new no-print glass surfaces give a pleasant feeling by touch and eliminate the imprint effect on push&pull surfaces and doors.

Yoga, une nouvelle dimension du contemporain : des conceptions d'intérieurs définies par des formes essentielles et des matériaux recyclés. Recherche de pureté et de tactilité. Les nouvelles surfaces en verre no-print confèrent une agréable sensation au toucher et éliminent les empreintes sur les plans et les portes à ouverture push&pull.







UNA PROPOSTA DALL'IMMAGINE HIGH-TECH:

volumi primari che definiscono una nuova geometria del contenere. I mobili pensili, che permettono un'infinita componibilità grazie agli elementi a giorno, ad anta e alle mensole con supporto a scomparsa.

A proposal coming from high-tech images: primary volumes, which define a new encompassing geometry.
Wall units, which enable an endless unit furniture setting, thanks to the open elements, door units and shelves with concealed support.

Une proposition suggérant une image hautement technologique : des volumes primaires qui définissent une nouvelle géométrie du meuble.
Les meubles suspendus permettant une modularité infinie grâce aux éléments ouverts ou avec porte et aux étagères avec support escamotable.





UNA COLLEZIONE IN
CUI L'ORIGINALITÀ
DEL DESIGN È
AFFIANCATA
DALLA VOLONTÀ

di formulare proposte in cui si incontrano essenze e metallo in una sintesi compositiva evoluta. La naturalezza del legno e la tecnicità del metallo si intersecano creando un layout compositivo naturale e di grande pregio.

A collection where the design novelty is backed by the will to formulate proposals in which fragrances and metal meet in an evolved constituent synthesis. The naturalness of wood and the technicity of metal criss-cross by creating a natural composition and high quality layout.

Une collection où l'originalité du design va de pair avec la volonté de formuler des propositions où les essences et le métal se rencontrent dans une synthèse de composition évoluée. La naturalité du bois et la technicité du métal s'entrecroisent en créant une composition naturelle et de haute qualité.





GRANDE ATTENZIONE PER I PARTICOLARI E PER GLI ACCESSORI

che semplificano ed agevolano lo svolgimento del lavoro. Tecnologia e funzionalità si integrano alle connessioni dei cablaggi e collegano il posto lavoro al mondo globale con una corretta gestione dei cavi.

Great attention for details and accessories that simplify and facilitate work development. Technology and practicality integrate with the wirings connections and connect the workplace to the global world with a correct management of cables.

Une attention spéciale aux détails et aux accessoires qui simplifient et facilitent l'exécution du travail. La technologie et la fonctionnalité se marient aux connexions des câblages et connectent le poste de travail au monde global suivant une gestion cohérente des câbles.





LAVORO SINGOLO O DI EQUIPE: SPAZI PER DECIDERE,

Lavoro singolo o di equipe: spazi per decidere, per aggregarsi, per consultarsi, per risolvere le necessità. Yoga ricerca armonia e risolve la componibilità dalla scrivania al grande tavolo riunione caratterizzato dal supporto canalizzato. Materiali e colori consentono di personalizzare il proprio spazio e creare l'equilibrio perfetto per ogni situazione.

Individual work or team work: spaces for decisions, aggregation, consulting and to solve needs. Yoga looks for harmony and solves the unite furniture setting from the desk to the large conference table characterized by the piped support. Materials and colours enable to customize one's own space and to create a perfect balance for every situation.

Travail individuel ou en équipe : des espaces pour décider, se rencontrer, se consulter, résoudre toute exigences. Yoga recherche l'harmonie et asservit la modularité du bureau à la grande table de réunion caractérisée par un support canalisé. Des matériaux et des couleurs permettant de personnaliser son espace personnel et de créer un équilibre parfait pour chaque situation.





POSTAZIONE "OPERATIVA" MULTIFUNZIONALE E NUCLEO CONVIVIALE

caratterizzato dal grande piano di lavoro che trova la negli elementi particolari , ante, cornici in alluminio, elementi verniciati, vetri extralight il proprio dettaglio caratterizzante. Gli elementi funzionali come i piedini regolabili, le maniglie, i passacavi creano un equilibrio nella massima coerenza stilistica.

Multifunctional "staff" position and convivial core characterized by a large worktop, which finds its own characterizing detail in the particular elements, doors, aluminium frames, varnished elements, extra-light glasses. The functional elements such as the adjustable feet, handles, cable management create a balance in the utmost stylistic coherence.

Poste « opérationnel » multifonction et noyau convivial caractérisé par un grand plan de travail qui trouve dans les détails, les portes, les cadres en aluminium, les éléments peints, les vitres extra light, l'élément caractéristique de chacun. Les éléments fonctionnels comme les pieds réglables, les poignées, les passe-câbles créent un équilibre dans le maximum de cohérence stylistique.









LEGGEREZZA, ELEGANZA E MODULARITÀ,

un progetto ispirato al fascino della modernità e alla essenzialità della funzione. Lo scaffale libreria è declinato in una infinità di finiture e colori. La struttura in alluminio verniciato e le mensole in cristallo o nobilitato colorato si adattano ad ogni ambiente tra infiniti giochi di riflessi.

Lightness, elegance and modularity, a project inspired to the appeal of modernity and the essentiality of the function. The bookcase shelf is presented in an endless number of finishes and colours. The varnished aluminium structure and the crystal or faced wood shelves can suit every setting among an endless number of games and reflexes.

Légèreté, élégance et modularité, un projet s'inspirant du charme de la modernité et de la fonctionnalité essentielle. Le meuble bibliothèque est décliné dans une gamme infinie de couleurs et de finitions. La structure en aluminium peint et les étagères en cristal ou avec revêtement en bois coloré s'adaptent à tout intérieur entre des jeux de reflets infinis.







PIANI AMPI, DUPLICABILI ALL'INFINITO, IL COLORE DEL LEGNO,

L'attenzione al design e l'abbinamento dei materiali per guardare oltre l'orizzonte conosciuto e trovare nuove idee e soluzioni sempre più evolute. Dal tavolo singolo al composto per creare spazi riunione dalle dimensioni infinite.

Wide surfaces, endlessly applicable, the colour of wood, the attention to design and the combination of materials to look beyond the known horizon and find new ideas and more and more evolved solutions. From single to composite tables, to create conference areas of endless dimensions.

De vastes plans, pouvant être dupliqués à l'infini, la couleur du bois, l'attention au design et à l'assortiment des matériaux pour regarder au-delà de l'horizon connu et trouver de nouvelles idées et des solutions de plus en plus à l'avant-garde. De la table individuelle à la composition pour créer des espaces réunion aux dimensions infinies.









PIANI IN VERA PELLE: UNA VERSIONE YOGA RICERCATA ED ESCLUSIVA.

Una collezione da accarezzare con le mani e con lo sguardo. La morbidezza della Pelle con i dettagli artigianali del MADE IN ITALY. L'essenzialità delle forme crea una naturale eleganza che predilige raffinati contrasti cromatici, nel valore della semplicità.

Worktops covered in genuine leather: a refined and exclusive version of Yoga. A collection to caress with hands and with eyes. The softness of the leather with handcrafted details of the MADE IN ITALY. The essentiality of shapes creates a natural elegance that prefers refined chromatic contrasts, in the value of simplicity.

Plateaux réalisés en cuir véritable: une version de la gamme Yoga recherchée et exclusive. Une collection à caresser avec les mains et avec les yeux. La douceur de la Cuir avec les détails artisanaux du MADE IN ITALY. Les formes essentielles créent une élégance naturelle qui prime les contrastes chromatiques raffinés, dans la valeur de la simplicité.

GEOMETRIE PURE E DETTAGLI STILISTICI IN SOTTILE CONTINUITÀ CON IL PASSATO E LA TRADIZIONE.

Un'estetica dei contrari apparenti, di materia e trasparenza, in piena armonia. Più che un sistema Yoga è una partitura aperta, un catalogo di possibilità con cui progettare regole ed eccezioni. Ordine senza monotonia: materiali, finiture e componenti sono variazioni tematiche con cui comporre nello spazio il ritmo delle nostre giornate.

Pure geometries and stylistic details in a subtle continuity with the past and the tradition. A kind of appearance of apparent opposites, of matter and transparency, in full harmony. Rather than being a system, Yoga can be defined as an open score, a catalogue of opportunities by which it is possible to design rules and exceptions. Order without monotony: Materials, finishes and components are theme variations with which to make up the rhythm of our days in space.

Des géométries pures et des détails stylistiques dans une continuité subtile avec le passé et la tradition. Une esthétique des contraires apparents, de la matière et de la transparence, en pleine harmonie. Plus qu'un système Yoga est une partition ouverte, un catalogue de possibilités avec lequel projeter des règles et des exceptions. De l'ordre sans monotonie: matériaux, finitions et composants sont des variations thématiques avec lesquelles composer dans l'espace le rythme de nos journées.







CONTENITORI MA ANCHE SEMPLICI RIPIANI APERTI E MODULI CHIUSI,

Contenitori ma anche semplici ripiani aperti e moduli chiusi, mensole e basi, consolle a muro, ma anche semplici tavoli circolari. Elementi per mostrare e per nascondere. Infinite declinazioni per sfruttare al meglio lo spazio grazie ad una completa gamma di composizioni che moltiplicano l'ecletticità del sistema.

Containers as well as simple open shelves and closed modules, shelves and bases, wall consoles, as well as simple round tables. Elements to show and to hide. Endless declinations to exploit the space to the fullest, thanks to a complete range of compositions, which multiply the eclectic quality of the system.

Des meubles de rangement mais aussi de simples tablettes ouvertes et des modules fermés, des étagères et des bases, des consoles murales, mais aussi de simples tables circulaires. Des éléments pour montrer et pour cacher. Des possibilités infinies pour exploiter de la meilleure façon l'espace grâce à une gamme complète de compositions qui multiplient l'éclectisme du système.





FINITURE E SOLUZIONI TECNICHE IN PRIMO PIANO PER DARE IL GIUSTO RISALTO

al progetto globale della collezione. Dettagli di un sistema funzionale per risolvere la connessione del proprio posto lavoro con il mondo. Funzionalità e razionalità; tutti i componenti sono predisposti per alloggiare cablaggi e cavi di alimentazione. Gonne frontali, porta-cpu, gambe intermedia canalizzata per ogni esigenza particolare.

Finishes and technical solutions in close-up to accentuate the global project of the collection. Details of a functional system to solve the connection of one's workstation with the world. Functionality and rationality, all the components are prearranged to lodge wirings and feeder cables. Modesty panels, CPU holder, central legs with integrated cable management for every special need.

Des finitions et des solutions techniques au premier plan pour faire ressortir de la meilleure façon possible le projet global de la collection. Les détails d'un système fonctionnel pour connecter son poste de travail au monde entier. Fonctionnalité et rationalité, tous les composants sont prévus pour loger des câblages et des câbles d'alimentation. Panneaux frontaux, porte-cpu, jambe intermédiaire canalisée pour toute exigence particulière.

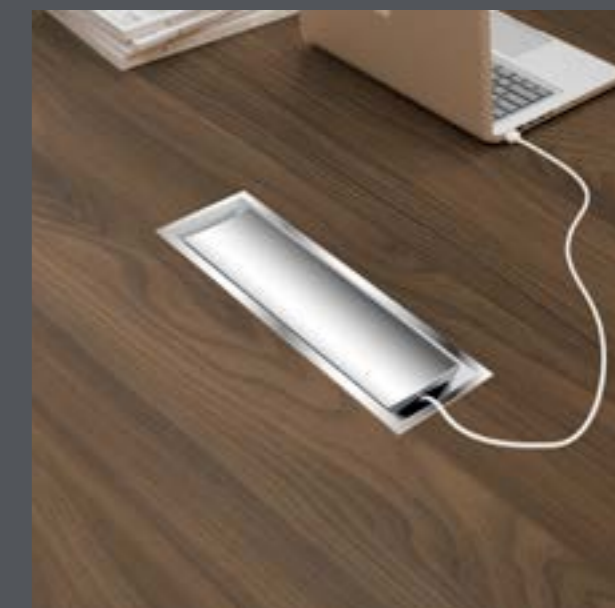

ESSENZE MELAMINICHE STANDARD

MELAMINE STANDARD TYPES
ESSENCES MELAMINE STANDARD

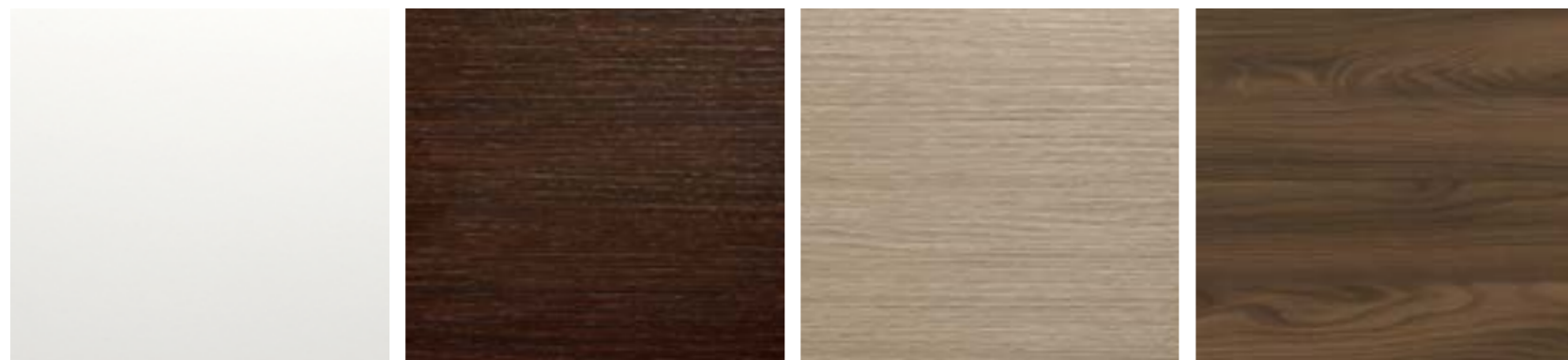

N3BD Bianco Dance
White Dance
Blanc Dance

N2WE Wengè
Wenge
Wenge

N3RT Rovere Twist
Durmast Twist
Chêne Twist

N3OC Olmo Classic
Elm Classic
Orme Classique

LACCATI OPACHI

MATT LAQUERED
LAQUEES MATES

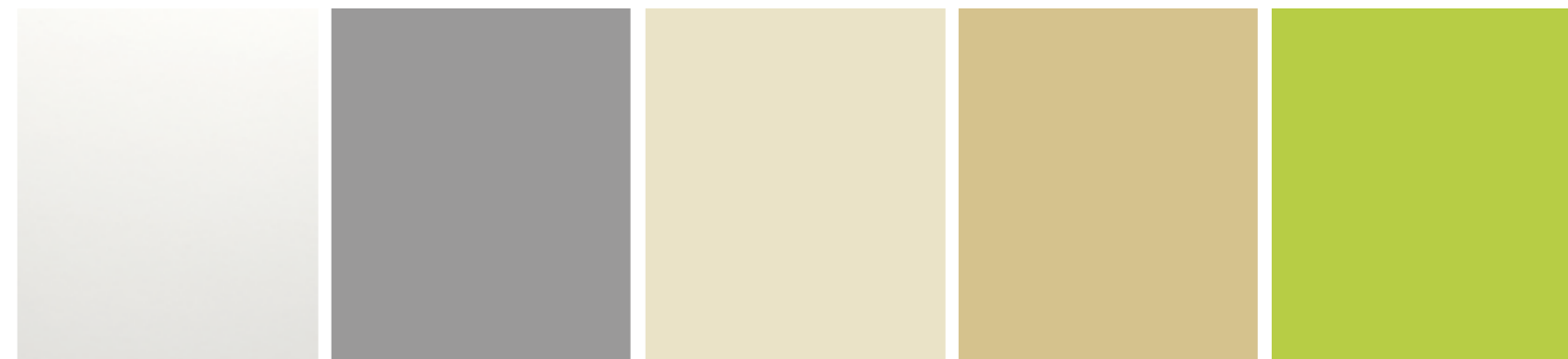

L_BD Bianco Dance
White Dance
Blanc Dance

L_GY Grigio Yoga
Grey Yoga
Gris Yoga

L_CR Cipria Rosata
Rosy Face Powder
Poudre Rose

L_SD Sabbia Desertica
Desert Sand
Sable Du Désert

L_VA Verde Acido
Acid Green
Vert Acide

ESSENZE MELAMINICHE ON DEMAND

MELAMINE ON DEMAND TYPES
ESSENCES MELAMINE ON DEMAND

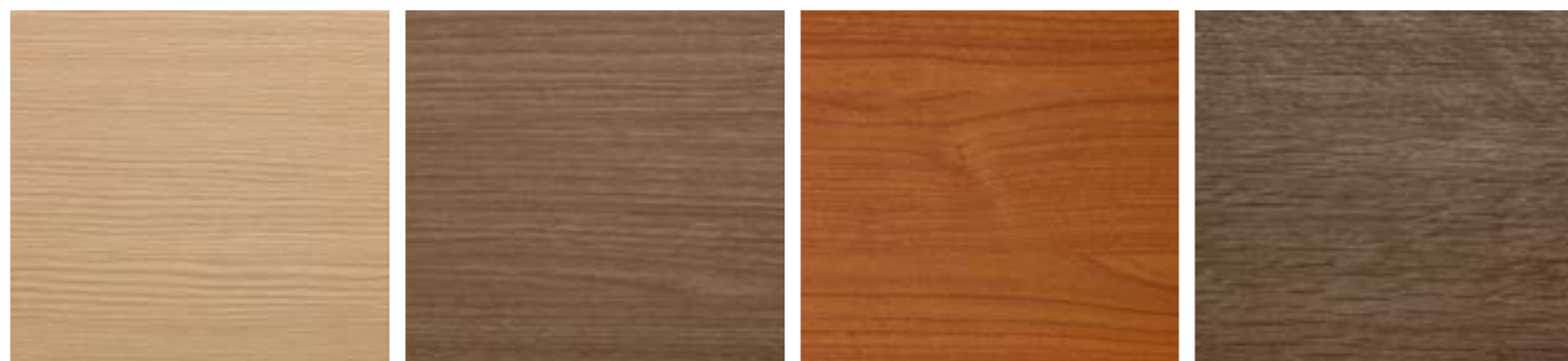

N3LG Larice Glam
Larch Glam
Mélèze Glam

N3NS Noce Soul
Walnut Soul
Noyer Soul

N3CB Cileglio Blues
Cherry Blues
Cerise Blues

N3RF Rovere Funk
Durmast Funk
Chêne Funk



L_TS Tortora Selvatica
Wild Dove
Tourterelle Sauvage

L_AB Arancione Brillante
Bright Orange
Orange Brillant

L_AC Aragosta Cotta
Steamed Lobster
Langouste Cuite

L_RC Rosso Cardinale
Cardenal Red
Rouge Cardinal

L_MC Melanzana Cruda
Raw Aubergine
Aubergine Crue

IMPIALLACCIATI

WOOD VENEER
PLAQUÉS



i1NC Noce chiaro
Light Walnut
Noyer Clair

i1NS Noce scuro
Dark Walnut
Noyer Sombre

i1RO Rovere
Durmast
Chene

i1WE Wengè'
Wenge'
Wenge'



L_BV Blu Vivo
Sparkling Blue
Bleu Vif

L_CL Cioccolato al latte
Milk Chocolate
Chocolat au Lait

L_GS Grigio Scuro
Dark Grey
Gris Sombre

L_NY Nero Yoga
Black Yoga
Noir Yoga

L_RL Ral - Ral - Ral

VETRI LACCATI
LACQUERED GLASSES
VERRES LAQUEES



E1BD Bianco Dance - White Dance Blanc Dance
E1GY Grigio Yoga - Grey Yoga Gris Yoga
E1GF Grigio Fango - Mud Grey Gris Boue
E1CT Cappuccino - Cappuccino Cappuccino
E1VA Verde Acido - Acid Green Vert Acide

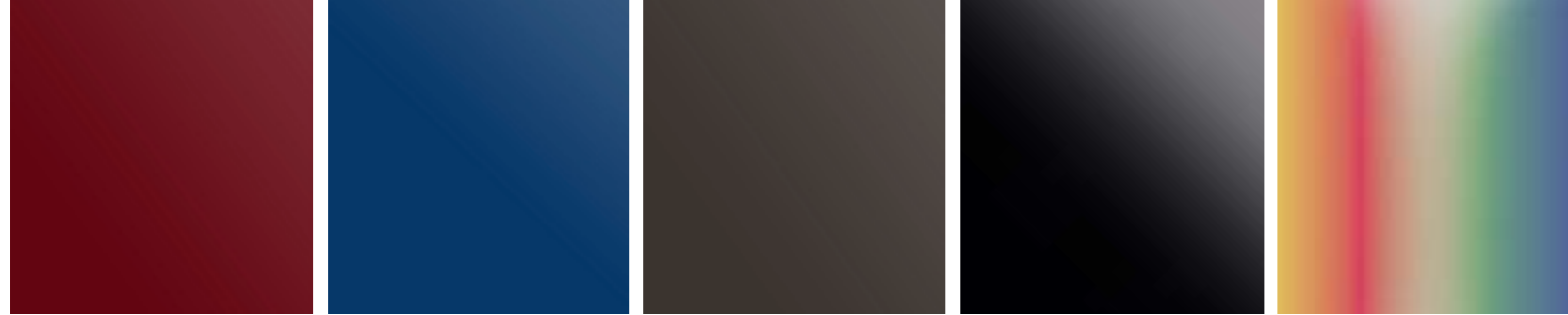

E1MS Marsala - Marsala Marsala
E1BV Blu Vivo - Sparkling Blue Blue Vif
E1MK Moka - Moka Moka
E1NY Nero Yoga - Black Yoga Noir Yoga
E1RL Ral - Ral - Ral

VETRI LACCATI NO-PRINT
NO-PRINT LACQUERED GLASSES
VERRES LAQUEES NO-PRINT

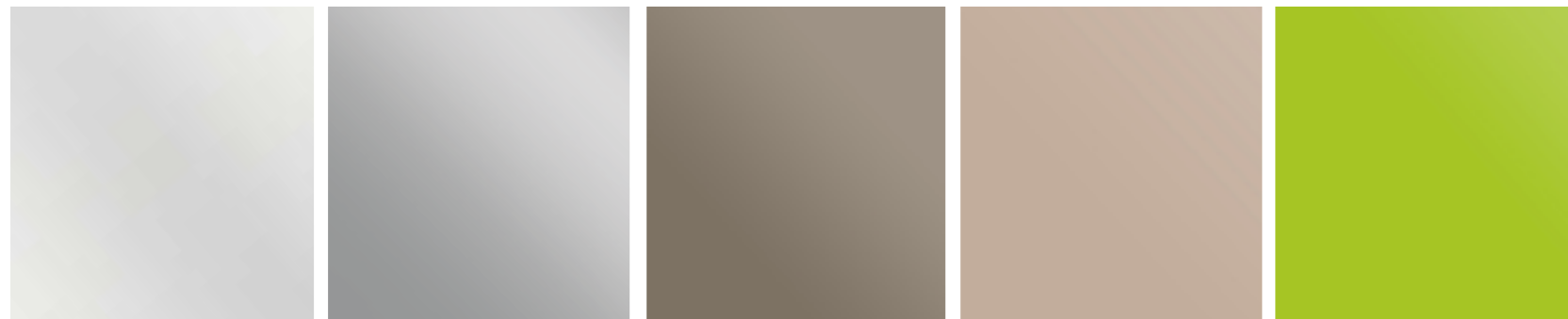

E3BD Bianco Dance - White Dance Blanc Dance
E3GY Grigio Yoga - Grey Yoga Gris Yoga
E3GF Grigio Fango - Mud Grey Gris Boue
E3CT Cappuccino - Cappuccino Cappuccino
E3VA Verde Acido - Acid Green Vert Acide

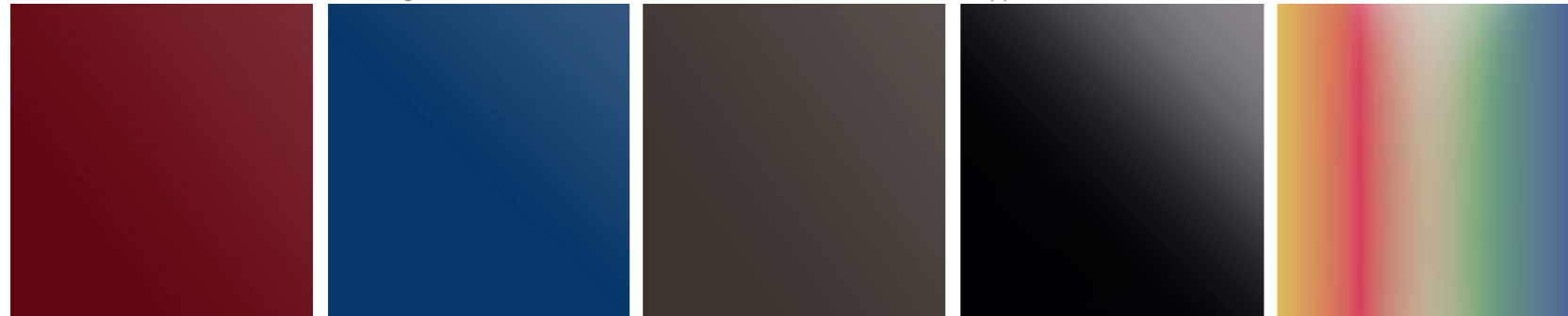

E3MS Marsala - Marsala Marsala
E3BV Blu Vivo - Sparkling Blue Blue Vif
E3MK Moka - Moka Moka
E3NY Nero Yoga - Black Yoga Noir Yoga
E3RL Ral - Ral - Ral

VETRI TRASPARENTI
CLEAR GLASS
VERRES TRANSPARENTES



E1EC Extrachiaro - Extra light Extra clair
E3VS Satinato NO-PRINT - NO-PRINT Satinated Satiné NO-PRINT
V1GE Grigio Europeo - European Grey Gris Européen

RIVESTIMENTI PELLE
LEATHER COVER
COUVERTURE EN CUIR



P1BG Beige - Beige Beige
P1AT Asfalto - Asphalt Asphalte
P1BN Blu Notte - Blue Night Bleu Nuit



P1MS Marsala - Marsala Marsala
P1CG Castagna - Chestnut Châtaigne
P1NE Nero - Black Noir

GAMBE - GIUNTI - TRAVI
 LEGS - JOINTS - BEAMS
 PIÉTEMENTS - LIAISON - POUTRE



A1BD/A2BD Bianco Dance
 White Dance
 Blanc Dance



A1GY/A2GY Grigio Yoga
 Grey Yoga
 Gris Yoga

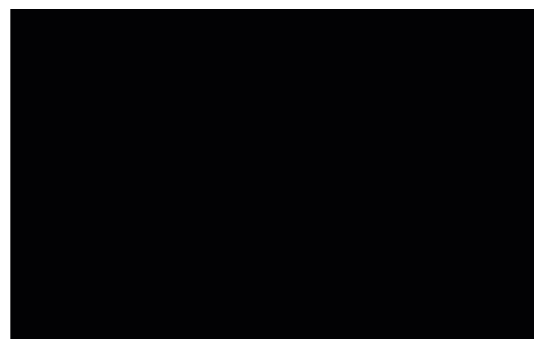

A1NY/A2NY Nero Yoga
 Black Yoga
 Noir Yoga



A1CF Cromo Funky
 Chrome Funky
 Chrome Funky



A2RL Ral - Ral - Ral

MANIGLIE
 HANDLES
 POIGNÉES

320mm



D912

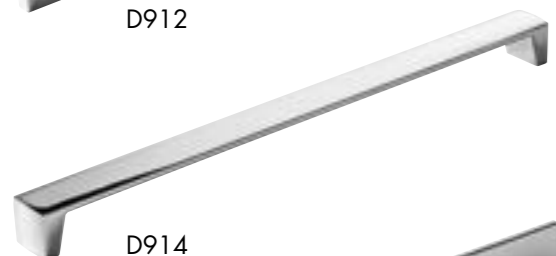

D914

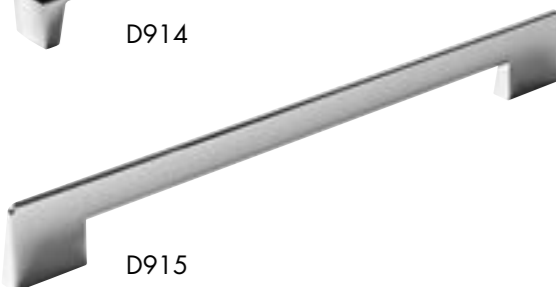

D915

160mm



D902



D904

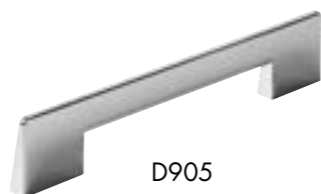

D905



ABBINAMENTI CONSIGLIATI GAMBA - GIUNTO

PER SCRIVANIE E TAVOLI CON PIANI ESSENZA, IMPIALLACCIATI, LACCATI ANTIGRAFFIO, VETRO LACCATO E VETRO NO PRINT

SUGGESTED COMBINATIONS LEG - JOINT

FOR DESKS AND TABLES WITH WORKTOPS IN MFC TYPES, VENEER, SCRATCH RESISTANT LACQUERED, LACQUERED GLASS AND NO-PRINT GLASS

ASSORTIMENTS RECOMMANDÉS PIÉTEMENT - LIAISON

POUR BUREAUX ET TABLES AVEC PLANS EN MÉLAMINÉ, PLAQUÉS, LAQUÉS ANTI-RAYURE, VERRRE LAQUÉ ET VETRE NO-PRINT



A1BD, A1BD

A1GY, A1GY

A1NY, A1NY

A1CF, A1CF

A2RL, A2RL

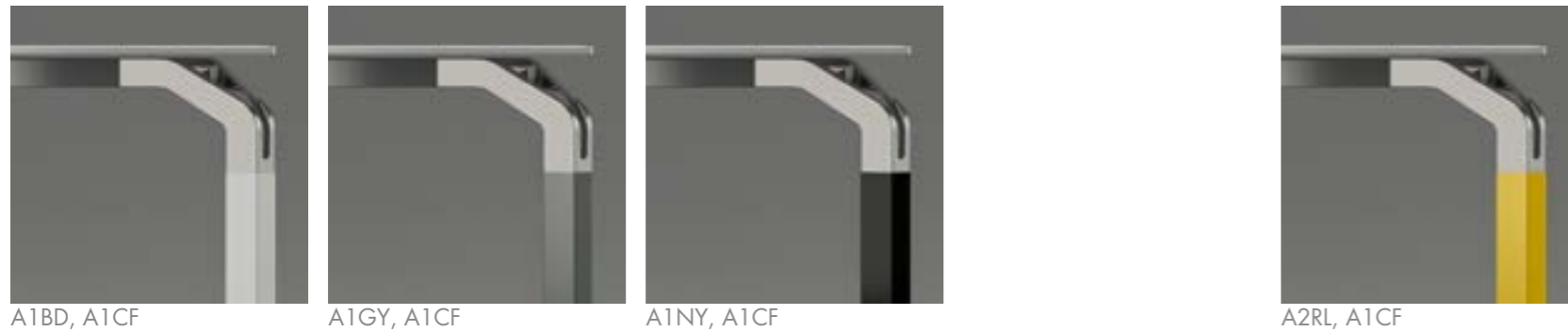

A1BD, A1CF

A1GY, A1CF

A1NY, A1CF

A2RL, A1CF

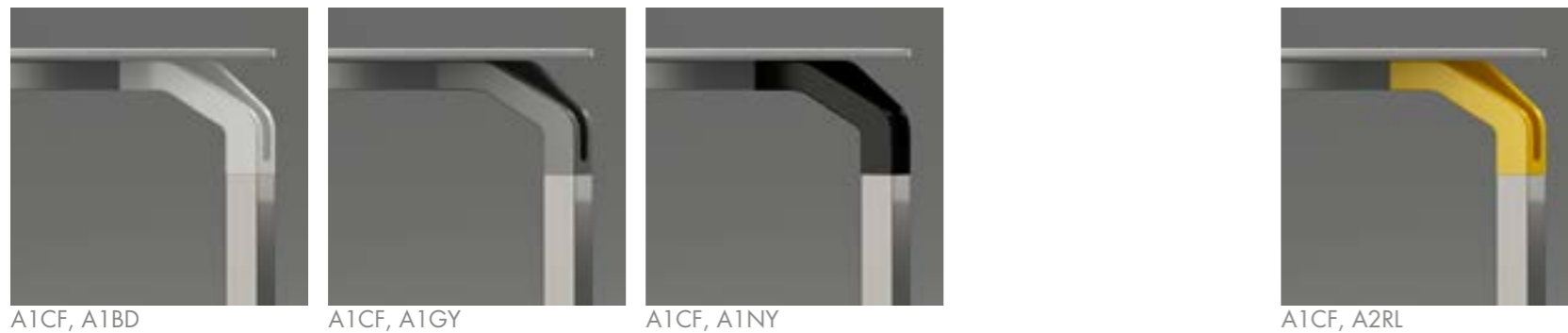

A1CF, A1BD

A1CF, A1GY

A1CF, A1NY

A1CF, A2RL

ABBINAMENTI CONSIGLIATI GAMBA - GIUNTO - TRAVE

PER SCRIVANIE E TAVOLI CON PIANIVETRO TRASPARENTE

SUGGESTED COMBINATIONS LEG-JOINT-BEAM

FOR DESKS AND MEETING TABLES WITH WORKTOPS IN TRANSPARENT GLASS

ASSORTIMENTS RECOMMANDÉS PIÉTEMENT-LIAISON-POUTRE

POUR BUREAUX ET TABLES AVEC PLANS EN VETRE TRASPARENT



A2BD, A2BD, A2BD

A2GY, A2GY, A2GY

A2NY, A2NY, A2NY

A1CF, A1CF, A1CF

A2RL, A2RL, A2RL

N.B.: IN QUESTI ABBINAMENTI PER I PIANI COPRENTI, LA TRAVE È NELLA FINITURA A1GY GRIGIO YOGA ED IL PIEDINO È SEMPRE CROMATO

NOTE: FOR THESE COMBINATIONS FOR BLIND WORKTOPS, THE BEAMS ARE ALWAYS IN FINISH A2GY YOGA GREY AND THE FEET ARE ALWAYS CHROME FINISH

ATTENTION: AVEC CES ASSORTIMENTS SI LES PLANS DE TRAVAUX NE SONT PAS TRASPARENTS, LA POUTRE EN FINITION A2GY GRIS YOGA ET LE PIED EST TOUJOURS CHROMÉ

COMPONI YOGA:
CREATE YOUR YOGA:
FAITES VOS YOGA:

1 - SCEGLI LA GAMBA CHOOSE LEG - CHOISIR PIÉTEMENT



A1BD, A2BD

A1GY, A2GY

A1NY, A2NY

A1CF

A2RL

2 - SCEGLI IL GIUNTO CHOOSE JOINT - CHOISIR LIAISON

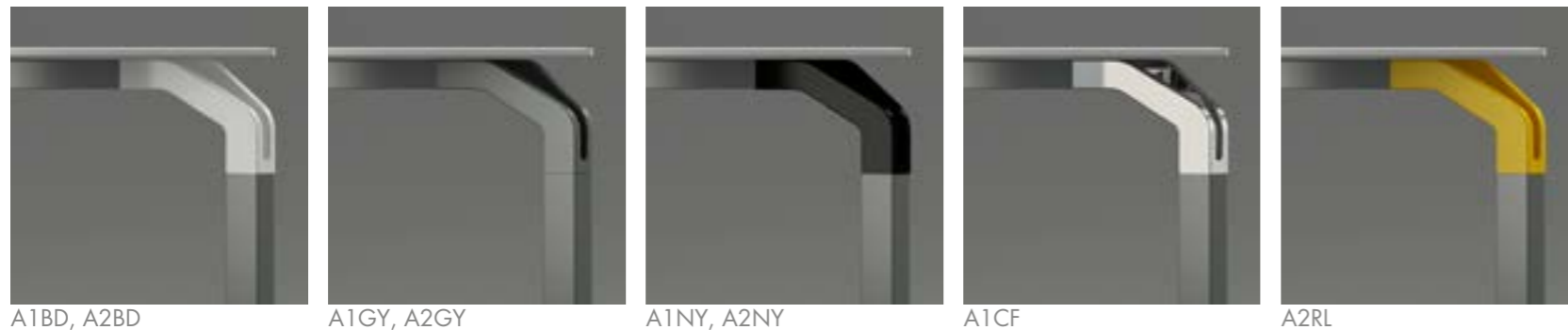

A1BD, A2BD

A1GY, A2GY

A1NY, A2NY

A1CF

A2RL

3 - SCEGLI LA TRAVE CHOOSE BEAMS - CHOISIR POUTRE



A2BD

A2GY

A2BNY

A1CF

A2RL

4 - SCEGLI IL PIANO CHOOSE WORKTOP - CHOISIR PLANS

IMPIALLACCIATI - WOOD VENEER - PLAQUES



ESSENZE MELAMINICHE STANDARD - MELAMINE STANDARD TYPES - ESSENCES MELAMINE STANDARD

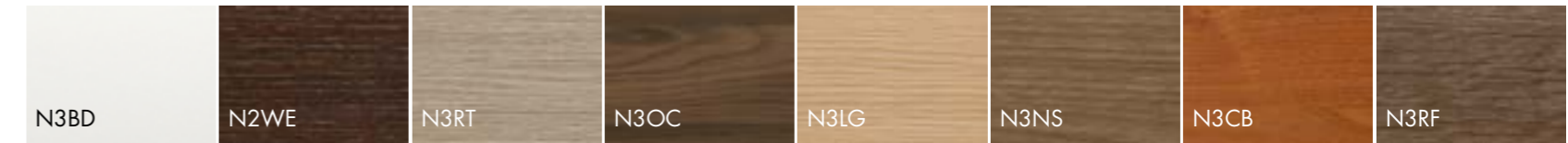

ESSENZE MELAMINICHE ON DEMAND - MELAMINE ON DEMAND TYPES - ESSENCES MELAMINE ON DEMAND

LACCATI OPACHI - MATT LAQUERED - LAQUEES MATES



VETRI LACCATI [E1] - LACQUERED GLASSES [E1] - VERRES LAQUEES [E1] | VETRI LACCATI NO-PRINT [E3] - NO-PRINT LACQUERED GLASSES [E3] - VERRES LAQUEES NO-PRINT [E3]

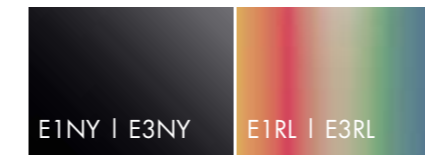

VETRI TRASPARENTI - CLEAR GLASS - VERRES TRANSPARENTES

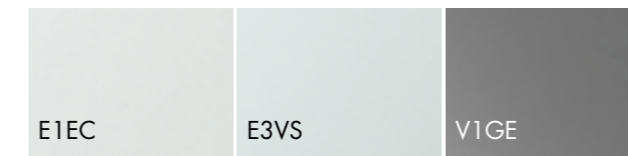

RIVESTIMENTI PELLE - LEATHER COVER - COUVERTURE EN CUIR



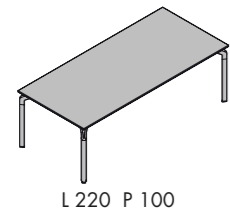

L 220 P 100

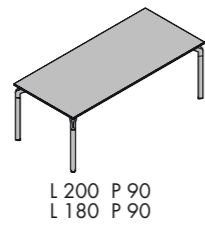

L 200 P 90
L 180 P 90

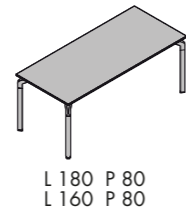

L 180 P 80
L 160 P 80

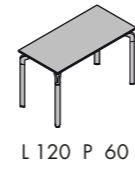

L 120 P 60

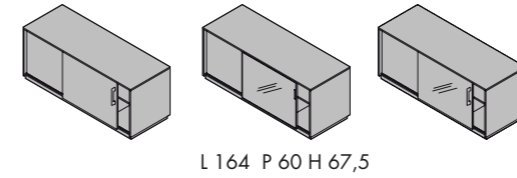

L 164 P 60 H 67,5

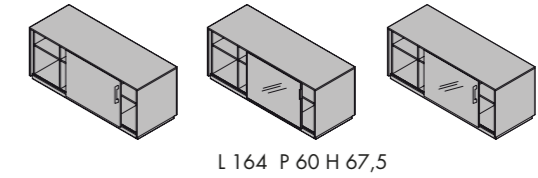

L 164 P 60 H 67,5

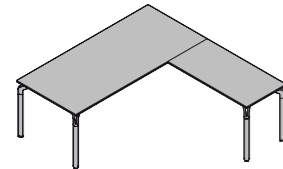

L 200 P 210
L 200 P 170

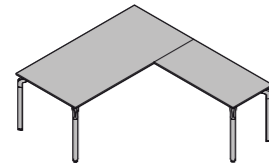

L 180 P 210
L 180 P 170

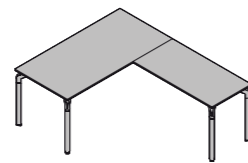

L 180 P 200
L 180 P 160

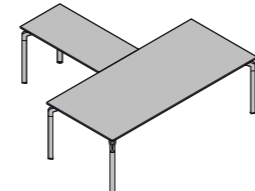

L 220 P 220
L 220 P 180

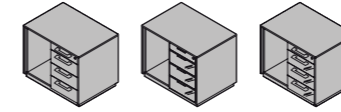

L 84 P 60 H 67,5

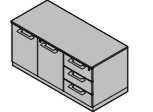
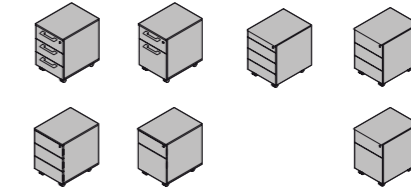

L 122 P 56 H 53

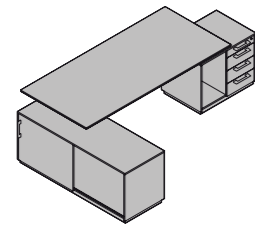

L 287 P 184

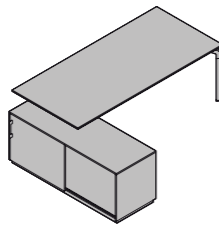

L 243 P 184
L 223 P 184
L 203 P 184

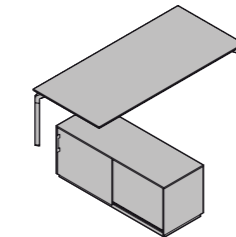

L 243 P 224
L 223 P 214
L 203 P 214

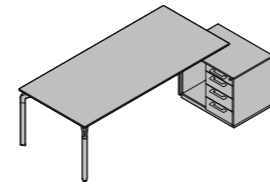

L 243 P 144
L 223 P 134
L 203 P 134

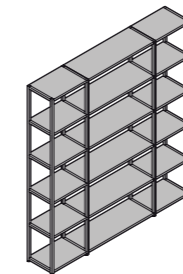

L 190 P 34,5 H 210

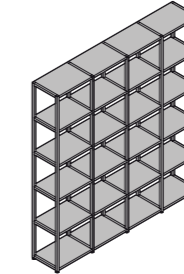

L 192,5 P 34,5 H 210

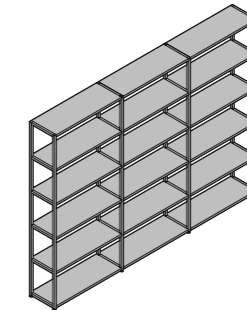

L 280 P 34,5 H 210

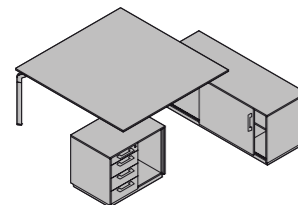

L 240 P 248

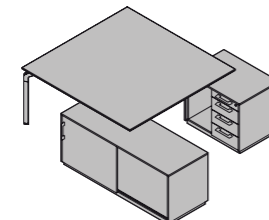

L 218 P 248

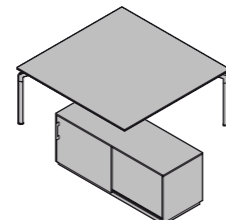

L 195 P 248

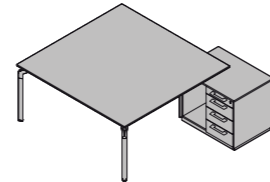

L 183 P 208

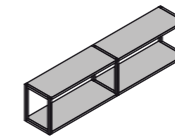

L 187,5 P 34,5 H 41,6

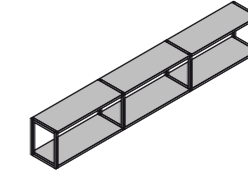

L 280 P 34,5 H 41,6

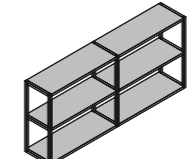

L 187,5 P 34,5 H 83,2

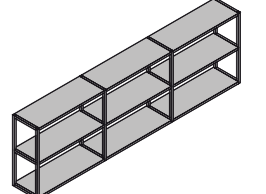

L 280 P 34,5 H 83,2

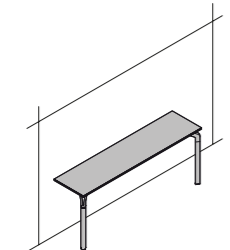

L 180 P 45
L 160 P 45
L 120 P 45

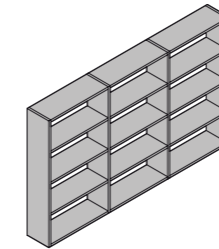

L 273 P 33 H 167

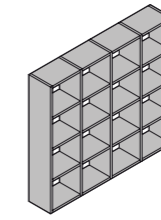

L 183 P 33 H 167

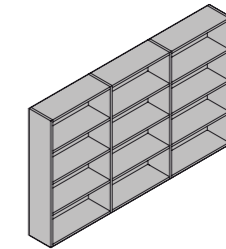

L 273 P 33 H 167

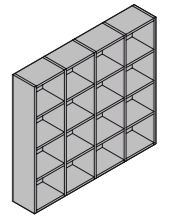

L 183 P 33 H 167

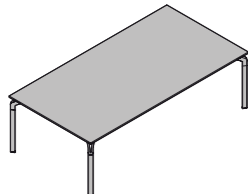

L 240 P 124

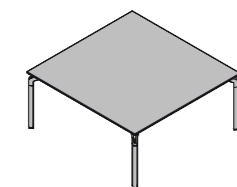

L 160 P 164

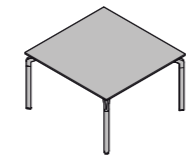

L 120 P 124

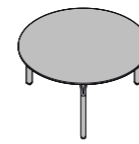

Ø 140

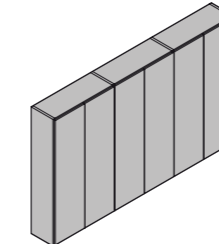

L 273 P 35 H 167

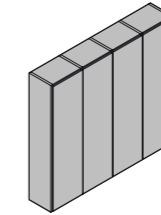

L 183 P 35 H 167

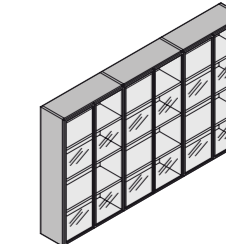

L 273 P 35 H 167

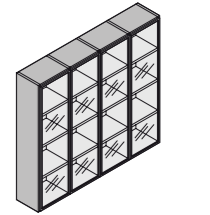

L 183 P 35 H 167

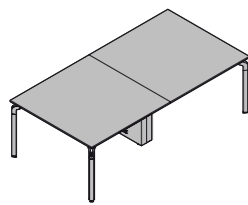

L 240 P 124

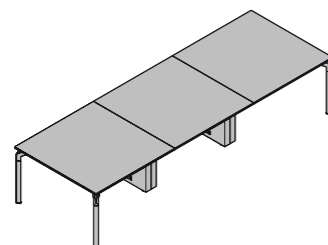

L 360 P 124

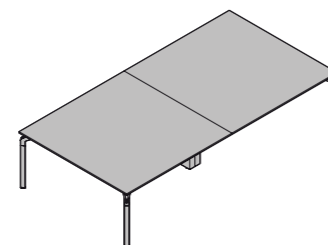

L 320 P 164

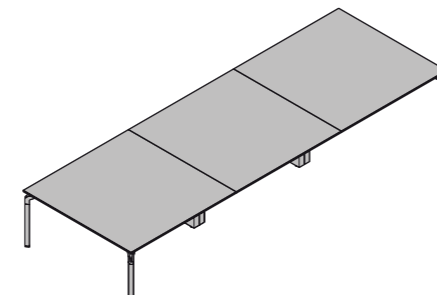

L 480 P 164

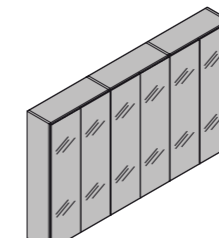

L 273 P 35 H 167

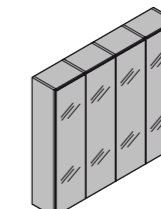

L 183 P 35 H 167

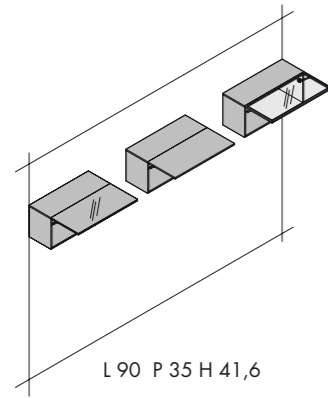

L 90 P 35 H 41,6

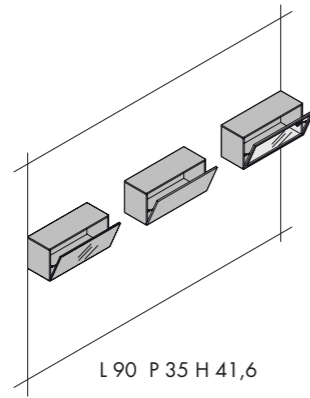

L 90 P 35 H 41,6

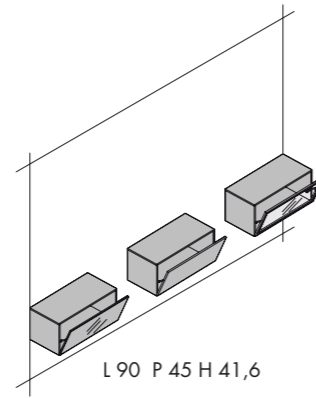

L 90 P 45 H 41,6

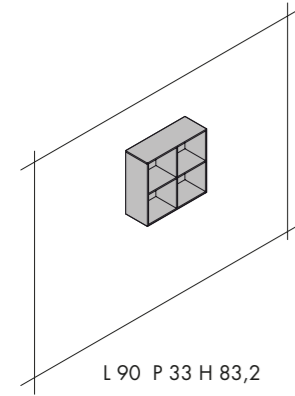

L 90 P 33 H 83,2

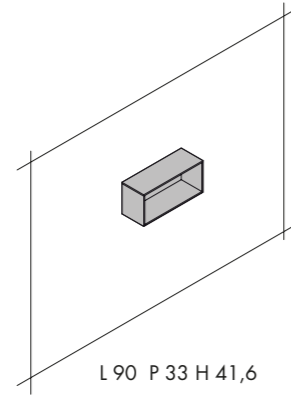

L 90 P 33 H 41,6

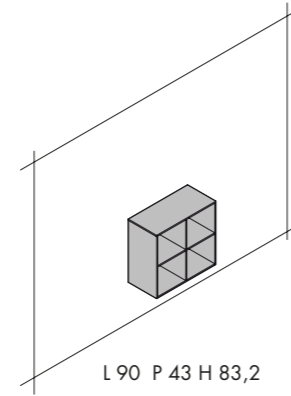

L 90 P 43 H 83,2

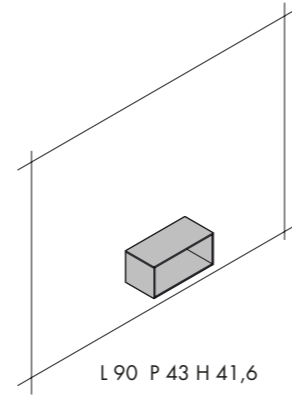

L 90 P 43 H 41,6

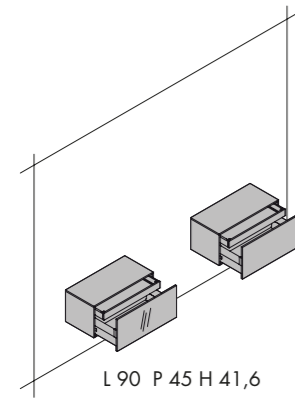

L 90 P 45 H 41,6

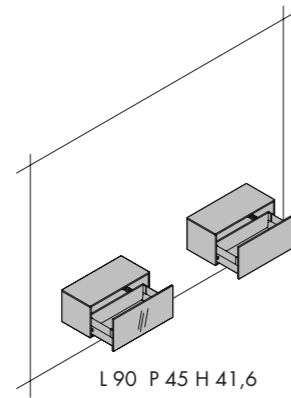

L 90 P 45 H 41,6

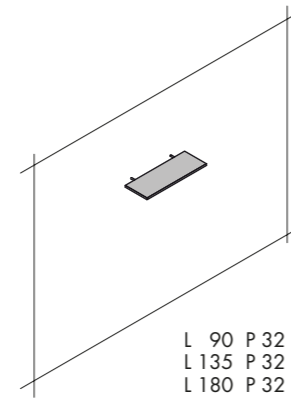

L 90 P 32 H 2,5
L 135 P 32 H 2,5
L 180 P 32 H 2,5

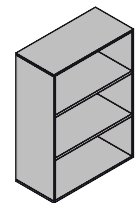

L 90 P 45 H 85
L 90 P 45 H 127
L 90 P 45 H 210

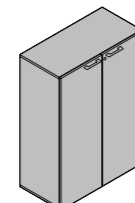

L 90 P 45 H 85
L 90 P 45 H 127
L 90 P 45 H 210

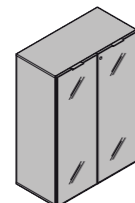

L 90 P 45 H 85
L 90 P 45 H 127
L 90 P 45 H 210

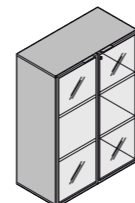

L 90 P 45 H 85
L 90 P 45 H 127
L 90 P 45 H 210



L 45 P 45 H 85
L 45 P 45 H 127
L 45 P 45 H 210

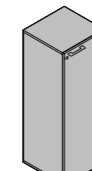

L 45 P 45 H 85
L 45 P 45 H 127
L 45 P 45 H 210



L 45 P 45 H 85
L 45 P 45 H 127
L 45 P 45 H 210

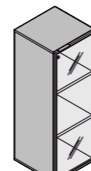

L 45 P 45 H 85
L 45 P 45 H 127
L 45 P 45 H 210

PAGG.	DESCRIZIONE MODELLO:	DESCRIZIONE FINITURE
04-05	Scrivania direzionale L160 P164; piano N2WE - gambe A1CF - giunti A1CF Mobile strutturale L164 P60; struttura N3NJ - ante E1NY - telaio 20/45 A1AL - top e fianchi N2WE Mobili contenitori H85; ante N2WE - maniglie D914 - top e fianchi N2WE	
06-07	Scrivania direzionale L200 P90; piano P1MS - gambe A1BD - giunti A1BD Mobile strutturale L164 P60; struttura N3BD - ante E1BD/E1MS - telaio 20/45 A1AL - top e fianchi N3BD Libreria alluminio H210; struttura A2BD - ripiani E1BD	
08-09	Scrivania direzionale L200 P90; piano E1BD - gambe A1BD - giunti A1CF Mobile di servizio L122 P55; ante N3BD - maniglie D904 - top e fianchi N3BD Mobili contenitori H85; ante N3BD - maniglie D914 - top e fianchi N3BD	
10-11	Scrivania direzionale L220 P100; piano E1EC - gambe A1CF - giunti A1CF - travi A1CF Datilò L120 P60; piano E1EC - gambe A1CF - giunti A1CF - travi A1CF Cassetiera: struttura e cassette M3CF Tavolo riunioni L240 P124; piano N3RT - gambe A1CF - giunti A1CF Mobili contenitori H210; ante N3RT - maniglia D912 - top e fianchi N3RT	
12-13	Scrivania direzionale L200 P90; piano V1GE - gambe A2NY - giunti A2NY - trave A2NY Mobile strutturale L164 P60; struttura L2NY - ante E1GY - telaio 20/45 A1AL - top e fianchi L2NY Libreria alluminio H210; struttura A2NY - ripiani E1NY Mobili contenitori H127; ante E1YG - telaio 20/45 A1AL - top e fianchi L2NY	
14-15	Tavolo riunioni L160 P164; piano E1NY - gambe A1BD - giunti A1BD Libreria melaminico H167; struttura L2BD - ante push&pull E2GY - frameless	
16-17	Scrivania direzionale L200 P90; piano L5BD - gambe A1BD - giunti A1BD Mobile di servizio L122 P55; ante L2BD - struttura N3BD Basi e pensili sospesi L90; struttura N3BD/N3NJ - ante push&pull L2BD/L2NY	
18-19	Scrivania direzionale L180 P90; piano N3RT - gambe A2NY - giunti A2NY - travi A2NY Basi e pensili sospesi L90; struttura N3NJ - ante push&pull E1EC/N3NJ - telaio 20/20 A2NY	
20-21	Scrivania con allungo L200 P210; piano i1NC - gambe A1BD - giunti A1BD Cassetiera: struttura e cassette i1NC - maniglie D902 Tavolo tondo Ø140; piano E1EC - gambe A2BD - giunti A2BD - trave A2BD Mobili contenitori H210; ante i1NC - maniglie D912 - ante E1BD - telaio 20/45 A2BD - top e fianchi i1NC	
22-23	Scrivania con allungo L200 P210; piano i1NS - gambe A1NY - giunti A1NY Cassetiera: struttura e cassette i1NS - maniglie D905 Tavolo riunioni L320 P164; piano i1NS - gambe A1NY - giunti A1NY Basi e pensili sospesi L90; struttura L2RC - ante push&pull L2RC Libreria alluminio H210; struttura A1AL - ripiani L2RC	
24-25	Scrivania con allungo L200 P210; piano N3RT - gambe A1CF/A1BD - giunti A1CF/A1BD Cassetiera: struttura e cassette N3RT - maniglie D904 Mobili contenitori H85; ante N3RT - maniglie D914 - top e fianchi N3RT	
26-27	Scrivania direzionale L200 P90; piano E1NY - gambe RAL7024 - giunti RAL7024 Mobile di servizio L122 P55; ante RAL7024 - maniglie D904 - top e fianchi L2NY Mobili contenitori H85; ante RAL7024 - maniglie D914 - top e fianchi L2NY Tavolo riunioni L480 P164; piano i1WE - gambe RAL7024 - giunti RAL7024 Mobili contenitori H127; ante E1NY - telaio 20/45 A1AL - top e fianchi RAL7024	
28-29	Scrivania direzionale L220 P100; piano L5TS - gambe A1BD - giunti A1BD Mobile strutturale L164 P60; struttura N3BD - ante E1BD - telaio 20/45 A1AL - top e fianchi L2TS Mobili contenitori H85; ante N3BD - maniglie D914 - top e fianchi N3RT Tavolo riunioni L160 P164; piano N3RT - gambe A1GY - giunti A1GY Basi e pensili sospesi L90; struttura N3BD - ante push&pull N3BD	
30-31	Scrivania direzionale L160 P164; piano i1WE - gambe A1CF - giunti A1CF Mobile strutturale L164 P60; struttura N3BD - ante E1BD - telaio 20/45 A1AL - top e fianchi N3BD Mobili contenitori H127; ante E1BD - telaio 20/45 A1AL - top e fianchi N3BD Scrivania direzionale L200 P90; piano E3GY - gambe A1GY - giunti A1GY Cassetiera: struttura e cassette N3BD Mobili contenitori H85; ante N3BD - maniglie D912 - top e fianchi L2GY	
32-33	Scrivania direzionale L160 P164; piano L5GY - gambe A1GY - giunti A1GY Mobile strutturale L164 P60; struttura L2GY - ante L2GY - top e fianchi L2GY; maniglia D902 Mobile strutturale L84 P60; struttura L2GY - cassette L2GY - top e fianchi L2GY - maniglia D902 Mobili contenitori H85; ante L2GY - maniglie D915 - top e fianchi L2GY	
34-35	Scrivania direzionale L220 P100; piano N3OC Mobile strutturale L164 P60; struttura N3NJ - ante E1NY - telaio 20/45 A1AL - top e fianchi N3OC Mobile strutturale L84 P60; struttura N3NJ - cassette N3OC - top e fianchi N3OC - maniglia D905 Tavolo riunioni L240 P124; piano N3OC - gambe A1BD - giunti A1BD Mobili contenitori H85; ante N3OC - maniglie D915 - top e fianchi N3OC	
36-37	Libreria alluminio H210; struttura A1AL - ripiani E1NY Libreria alluminio H210; struttura A2BD - ripiani E1NY	
38-39	Scrivania direzionale con allungo frontale L220 P220; piano N2WE - gambe A1CF - giunti A1CF Gonna frontale H41; struttura N2WE Cassetiera: struttura e cassette M3CF Mobili contenitori H210; ante N2WE - maniglie D915 - ante E1NY - telaio 20/45 A1AL - top e fianchi N2WE	
42-43	Tavolo riunioni L480 P164; piano E3BD - gambe A1BD - giunti A1BD Mobili contenitori H210; struttura N3BD - ante N3BD - schienale L2TS - maniglia D914	
44-45	Tavolo riunioni L160 P164; piano RAL8019 - gambe RAL8019 - giunti A1CF Tavolo tondo Ø140; piano E3BD - gambe A1BD - giunti A1CF Libreria melaminico H167; struttura RAL8019 - ante push&pull E3BD	
46-47	Tavolo riunioni L480 P164; piano P1NE - gambe A1NY - giunti A1NY Mobili contenitori H210; struttura N3BD - ante L2NY - maniglie D915	
48-49	Tavolo riunioni L240 P124; piano E1EC - gambe A2NY - giunti A2NY - trave A2NY Mobili contenitori H85; ante L2GS - maniglie D915 - top e fianchi L2GS	
50-51	Tavolo riunioni L240 P124; piano E1EC - gambe A2NY - giunti A2NY - trave A2NY Mobili contenitori H210; struttura N3NJ - ante N3RT - maniglie D904 Libreria alluminio H210; struttura A2NY - ripiani L2NY	
52-53	Tavolo riunioni L240 P124; piano E1GY - gambe A1CF - giunti A1CF Mobili contenitori H85; ante N3BD - maniglie D915 - top e fianchi N3BD Pensili alluminio: struttura A1AL - ripiani E1GY Consolle L180 P45; piano i1WE - gambe A1CF - giunti A1CF Cassetiera: struttura e cassette M3CF Pensili alluminio: struttura A2BD - ripiani E1NY	
54-55	Scrivania direzionale L180 P80; piano N3OC - gambe A1CF - giunti A1CF Mobile strutturale L164 P60; struttura N3BD - ante N3OC - maniglia D905 - top e fianchi N3OC Gonna frontale H41; struttura N3OC	

MODEL DESCRIPTION- FINISHINGS DESCRIPTION

Executive desk L160 D164: desk top N2WE - legs A1CF - joints A1CF
Supporting container L164 D60: structure N3NJ - door E1NY - frame 20/45 A1AL - top and sides N2WE
Storage units H85: doors N2WE - handles D914 - top and sides N2WE

Executive desk L200 D90: desk top P1MS - legs A1BD - joints A1BD
Supporting container L164 D60: structure N3BD - door E1BD/E1MS - frame 20/45 A1AL - top and sides N3BD
Aluminium Bookcase H210: structure A2BD - shelves E1BD

Executive desk L200 D90: desk top E1BD - legs A1BD - joints A1CF
Service unit L122 D55: door N3BD - handles D904 - top and sides N3BD
Storage units H85: doors N3BD - handles D914 - top and sides N3BD

Executive desk L220 D100: desk top E1EC - legs A1CF - joints A1CF - beams A1CF
Side desk L120 D60: desk top E1EC - legs A1CF - joints A1CF - beams A1CF
Pedestal: structure and drawer fronts M3CF
Meeting table L240 D124: desk top N3RT - legs A1CF - joints A1CF
Storage units H210: doors N3RT - handles D912 - top and sides N3RT

Executive desk L200 D90: desk top V1GE - legs A2NY - joints A2NY - beams A2NY
Supporting container L164 P60: structure L2NY - door E1GY - frame 20/45 A1AL - top and sides L2NY
Aluminium Bookcase H210: structure A2NY - shelves E1NY
Storage units H127: doors E1YG - frame 20/45 A1AL - top and sides L2NY

Meeting table L160 D164: desk top E1NY - legs A1BD - joints A1BD
MFC Bookcase H167: structure L2BD - frameless door push&pull E2GY

Executive desk L200 D90: desk top L5BD - legs A1BD - joints A1BD
Service unit L122 D55: door L2BD - structure N3BD
Hanging bases and upper cabinets L90: structure N3BD/N3NJ - door push&pull L2BD/L2NY

Executive desk L180 D90: desk top N3RT - legs A2NY - joints A2NY - beams A2NY
Hanging bases and upper cabinets L90: structure N3NJ - door push&pull E1EC/N3NJ - frame 20/20 A2NY

Desk with side extension L200 D210: desk top i1NC - legs A1BD - joints A1BD
Pedestal: structure and drawer fronts i1NC - handles D902
Round table Ø140: desk top E1EC - legs A2BD - joints A2BD - beams A2BD
Storage units H210: doors i1NC - handles D912 - doors E1BD - frame 20/45 A2BD - top and sides i1NC

Desk with side extension L200 D210: desk top i1NS - legs A1NY - joints A1NY
Pedestal: structure and drawer fronts i1NS - handles D905
Meeting table L320 D164: desk top i1NS - legs A1NY - joints A1NY
Hanging bases and upper cabinets L90: structure L2RC - doors push&pull L2RC
Aluminium Bookcase H210: structure A1AL - shelves L2RC

Desk with side extension L200 D210: desk top N3RT - legs A1CF/A1BD - joints A1CF/A1BD
Pedestal: structure and drawer fronts N3RT - handles D904
Storage units H85: doors N3RT - handles D914 - top and sides N3RT

Executive desk L200 D90: desk top E1NY - legs RAL7024 - joints RAL7024
Service unit L122 D55: doors RAL7024 - handles D904 - top and sides L2NY
Storage units H85: doors RAL7024 - handles D904 - top and sides L2NY
Meeting table L480 D164: desk top i1WE - legs RAL7024 - joints RAL7024
Storage units H127: doors E1NY - frame 20/45 A1AL - top and sides RAL7024

Executive desk L220 D100: desk top LSTS - legs A1BD - joints A1BD
Supporting container L164 D60: structure N3BD - door E1BD - frame 20/45 A1AL - top and sides L2TS
Storage units H85: doors N3BD - handles D914 - top and sides N3RT
Meeting table L160 D164: desk top N3RT - legs A1GY - joints A1GY
Hanging bases and upper cabinets L90: structure N3BD - doors push&pull N3BD

Executive desk L160 P164 : desk top i1WE - legs A1CF - joints A1CF
Supporting container L164 D60: structure N3BD - door E1BD - frame 20/45 A1AL - top and sides N3BD
Storage units H127: doors E1BD - frame 20/45 A1AL - top and sides N3BD
Executive desk L200 D90: desk top E3GY - legs A1GY - joints A1GY
Pedestal: structure and drawer fronts N3BD
Storage units H85: doors N3BD - handles D912 - top and sides L2GY

Executive desk L160 D164: desk top L5GY - legs A1GY - joints A1GY
Supporting container L164 D60: structure L2GY - door L2GY - top and sides L2GY - handles D902
Supporting container L84 D60: structure L2GY - drawer fronts L2GY - top and sides L2GY - handles D902
Storage units H85: doors L2GY - handles D915 - top and sides L2GY

Executive desk L220 D100: desk top N3OC
Supporting container L164 D60: structure N3NJ - door E1NY - frame 20/45 A1AL - top and sides N3OC
Supporting container L84 D60: structure N3NJ - drawer fronts N3OC - top and sides N3OC - handles D905
Meeting table L240 D124: desk top N3OC - legs A1BD - joints A1BD
Storage units H85: doors N3OC - handles D915 - top and sides N3OC

Aluminium Bookcase H210: structure A1AL - shelves E1NY
Aluminium Bookcase H210: structure A2BD - shelves E1NY

Executive desk with front extension L220 D220: desk top N2WE - legs A1CF - joints A1CF
Modesty panel H41: structure N2WE
Pedestal: structure and drawer fronts M3CF
Storage units H210: doors N2WE - handles D915 - doors E1NY - frame 20/45 A1AL - top and sides N2WE

Meeting table L480 D164: desk top E3BD - legs A1BD - joints A1BD
Storage units H210: structure N3BD - doors N3BD - back L2TS - handles D914

Meeting table L160 D164: desk top RAL8019 - legs RAL8019 - joints A1CF
Round meeting table Ø140 : desk top E3BD - legs A1BD - joints A1CF
MFC Bookcase H167: structure RAL8019 - doors push&pull E3BD

Meeting table L480 D164: desk top P1NE - legs A1NY - joints A1NY
Storage units H210: structure N3BD - doors L2NY - handles D915

Meeting table L240 D124: desk top E1EC - legs A2NY - joints A2NY - beams A2NY
Storage units H85: doors L2GS - handles D915 - top and sides L2GS

Meeting table L240 D124: desk top E1EC - legs A2NY - joints A2NY - beams A2NY
Storage units H210: structure N3NJ - doors N3RT - handles D904
Aluminium Bookcase H210: structure A2NY - shelves L2NY

Meeting table L240 D124: desk top E1GY - legs A1CF - joints A1CF
Storage units H85: doors N3BD - handles D915 - top and sides N3BD
Aluminium hanging cabinets: structure A1AL - shelves N3BD
Console L180 D45: work top i1WE - legs A1CF - joints A1CF
Pedestal: structure and drawer fronts M3CF
Aluminium hanging cabinets: structure A2BD - shelves E1NY

Executive desk L180 D80: desk top N3OC - legs A1CF - joints A1CF
Supporting container L164 D60: structure N3BD - door N3OC - handle D905 - top and sides N3OC
Modesty panel H41: structure N3OC

DESCRIPTION DE MODÈLE - DESCRIPTION DE FINITIONS

Bureau direction L160 P164: plateau N2WE - piétement A1CF - liaisons A1CF
Élément de rangement L164 P60: structure N3NJ - porte E1NY - cadre 20/45 A1AL - top et panneaux latéraux N2WE
Armoires H85: portes N2WE - poignées D914 - top et panneaux latéraux N2WE

Bureau direction L200 P90: plateau P1MS - piétement A1BD - liaisons A1BD
Élément de rangement L164 P60: structure N3BD - porte E1BD/E1MS - cadre 20/45 A1AL - top et panneaux latéraux N3BD
Bibliothèque en alu H210:structure A2BD - étagères E1BD

Bureau direction L200 P90: plateau E1BD - piétement A1BD - liaisons A1CF
Meuble de rangement L122 P55: portes N3BD - poignées D904 - top et panneaux latéraux N3BD
Armoires H85: portes N3BD - poignées D914 - top et panneaux latéraux N3BD

Bureau direction L220 P100: plateau E1EC - piétement A1CF - liaisons A1CF - poutres A1CF T
able auxiliaire L120 P60: plateau E1EC - piétement A1CF - liaisons A1CF - poutres A1CF
Caisson: structure et tiroirs M3CF
Table réunion L240 P124: plateau N3RT - piétement A1CF - liaisons A1CF
Armoires H210: portes N3RT - poignée D912 - top et panneaux latéraux N3RT

Bureau direction L200 P90: plateau V1CE - piétement A2NY - liaisons A2NY - poutre A2NY
Élément de rangement L164 P60: structure L2NY - porte E1GY - cadre 20/45 A1AL - top et panneaux latéraux L2NY
Bibliothèque en alu H210: structure A2NY - étagères E1NY
Armoires H127: portes E1YG - cadre 20/45 A1AL - top et panneaux latéraux L2NY

Table réunion L160 P164: plateau E1NY - piétement A1BD - liaisons A1BD
Bibliothèque en mélaminé H167: structure L2BD - porte push&pull E2GY - sans cadre

Bureau direction L200 P90: plateau L5BD - piétement A1BD - liaisons A1BD
Meuble de rangement L122 P55: porte L2BD - structure N3BD
Éléments de rangement suspendus L90: structure N3BD/N3NJ - porte push&pull L2BD/L2NY

Bureau direction L180 P90: plateau N3RT - piétement A1NY - liaisons A1NY
Éléments de rangement suspendus L90: structure N3NJ - porte push&pull E1EC - cadre 20/20 A2NY

Bureau avec retour L200 P210: plateau i1NC - piétement A1BD - liaisons A1BD
Caisson: structure et tiroirs i1NC - poignées D902
Table ronde Ø140: plateau E1EC - piétement A2BD - liaisons A2BD - poutre A2BD
Armoires H210: portes i1NC - poignées D912 - portes E1BD - cadre 20/45 A2 BD - top et panneaux latéraux i1NC

Bureau avec retour L200 P210: plateau i1NS - piétement A1NY - liaisons A1NY
Caisson: structure et tiroirs i1NS - poignées D905
Table réunion L320 P164: plateau i1NS - piétement A1NY - liaisons A1NY
Éléments de rangement suspendus L90: structure L2RC - portes push&pull L2RC
Bibliothèque en alu H210:structure A1AL - étagères L2RC

Bureau avec retour L200 P210: plateau N3RT - piétement A1CF/A1BD - liaisons A1CF/A1BD
Caisson: structure et tiroirs N3RT - poignées D904
Armoires H85: portes N3RT - poignées D914 - top et panneaux latéraux N3RT

Bureau direction L200 P90: plateau E1NY - piétement RAL7024 - liaisons RAL7024
Meuble de rangement L122 P55: porte RAL7024 - poignées D904 - top et panneaux latéraux L2NY
Armoires H85: portes RAL7024 - poignées D914 - top et panneaux latéraux L2NY
Table réunion L480 P164: plateau i1WE - piétement RAL7024 - liaisons RAL7024
Armoires H127: portes E1NY - cadre 20/45 A1AL - top et panneaux latéraux RAL7024

Bureau direction L220 P100: plateau LSTS - piétement A1BD - liaisons A1BD
Élément de rangement L164 P60: structure N3BD - porte E1BD - cadre 20/45 A1AL - top et panneaux latéraux L2TS
Armoires H85: portes N3BD - poignées D914 - top et panneaux latéraux N3RT
Table réunion L160 P164: plateau N3RT - piétement A1GY - liaisons A1GY
Éléments de rangement suspendus L90: structure N3BD - porte push&pull N3BD

Bureau direction L160 P164 : plateau i1WE - piétement A1CF - liaisons A1CF
Élément de rangement L164 P60: structure N3BD - porte E1BD - cadre 20/45 A1AL - top et panneaux latéraux N3BD
Armoires H127: porte E1BD -cadre 20/45 A1AL - top et panneaux latéraux N3BD
Bureau direction L200 P90: plateau E3GY - piétement A1GY - liaisons A1GY
Caisson: structure et tiroirs N3BD
Armoires H85: portes N3BD - poignées D912 - top et panneaux latéraux L2GY

Bureau direction L160 P164: plateau L5GY - piétement A1GY - liaisons A1GY
Élément de rangement L164 P60: structure L2GY - porte L2GY - top et panneaux latéraux L2GY - poignée D902
Élément de rangement L84 P60: structure L2GY - tiroirs L2GY - top et panneaux latéraux L2GY - poignée D902
Armoires H85: portes L2GY - poignées D915 - top et panneaux latéraux L2GY

Bureau direction L220 P100: plateau N3OC
Élément de rangement L164 P60: structure N3NJ - porte E1NY - cadre 20/45 A1AL - top et panneaux latéraux N3OC
Élément de rangement L84 P60: structure N3NJ - tiroirs N3OC - top et panneaux latéraux N3OC - poignées D905
Table réunion L240 P124: plateau N3OC - piétement A1BD - liaisons A1BD
Armoires H85: portes N3OC - poignées D915 - top et panneaux latéraux N3OC

Bibliothèque en alu H210: structure A1AL - étagères E1NY
Bibliothèque en alu H210: structure A2BD - étagères E1NY

Bureau direction avec extension frontale L220 P220: plateau N2WE - piétement A1CF - liaisons A1CF
Voile de fond H41: structure N2WE
Caisson: structure et tiroirs M3CF
Armoires H210: portes N2WE - handles D915 - portes E1NY - cadre 20/45 A1AL - top et panneaux latéraux N2WE

Table réunion L480 P164: plateau E3BD - piétement A1BD - liaisons A1BD
Armoires H210: structure N3BD - portes N3BD - dos L2TS - poignée D914

Table réunion L160 P164: plateau RAL8019 - piétement RAL8019 - liaisons A1CF
Table ronde Ø140 : plateau E3BD - piétement A1BD - liaisons A1CF
Bibliothèque en mélaminé H167: structure RAL8019 - porte push&pull E3BD

Table réunion L480 P164: plateau P1NE - piétement A1NY - liaisons A1NY
Armoires H210: structure N3BD - portes L2NY - poignées D915

Table réunion L240 P124: plateau E1EC - piétement A2NY - liaisons A2NY - poutre A2NY
Armoires H85: portes L2GS - poignées D915 - top et panneaux latéraux L2GS

Table réunion L240 P124: plateau E1EC - piétement A2NY - liaisons A2NY - poutre A2NY
Armoires H210: structure N3NJ - portes N3RT - poignées D904
Bibliothèque en alu H210: structure A2NY - étagères L2NY

Table réunion L240 P124: plateau E1GY - piétement A1CF - liaisons A1CF
Armoires H85: portes N3BD - poignées D915 - top et panneaux latéraux N3BD
Éléments de rangement en alu, suspendus: structure A1AL - étagères N3BD
Table auxiliaire L180 P45: plateau i1WE - piétement A1CF - liaisons A1CF
Caisson: structure et tiroirs M3CF
Éléments de rangement en alu, suspendus: structure A2BD - étagères E1NY

Bureau direction L180 P80: plateau N3OC - piétement A1CF - liaisons A1CF
Élément de rangement L164 P60: structure N3BD - porte N3OC - poignée D905 - top et panneaux latéraux N3OC
Voile de fond H41: structure N3OC

Mobilpref S.p.A. si riserva il diritto di apportare ai propri prodotti le modifiche ritenute utili o necessarie, senza pregiudicare le caratteristiche essenziali dei prodotti stessi.

Mobilpref S.p.A. reserves itself the right to effectuate any modifications deemed useful or necessary to its products, provided such modifications do not interfere with the essential characteristics of said products.

Mobilpref S.p.A. se réserve le droit d’apporter les modifications jugées utiles ou nécessaires à ses propres produits, sans compromettre les caractéristiques essentielles des produits eux-mêmes.



Design: solodesign
A.D. e progetto grafico:
info@pubblicom.eu
Immagini: Virtual Design - TN
Stampa: Grafiche Ricciarelli
Edizione 02; 06.2015

The logo for 'about OFFICE' is displayed on a dark grey square background. The word 'about' is written in a bold, lowercase, white sans-serif font. The letter 't' is stylized with a red square at its top right corner. Below 'about', the word 'OFFICE' is written in a smaller, uppercase, white sans-serif font with wide letter spacing.

about
OFFICE

About Office
Mobilpref S.p.A.
Via Carlo Maccari, 1
Zona Industriale Baraccola Sud
60131 Ancona (AN) Italy
t. +39 071.2906920 / f. +39 071.2866429
info@about-office.it / www.about-office.it